



Touchpoint Pro

REVISIONS

Revision History

| Revision | Comment | Date |
|-----------------|----------------|-------------|
| Issue 1 | A04815 | Nov 2016 |
| Issue 2 | A04939 | Jan 2017 |
| Issue 3 | A05034 | Oct 2017 |
| Issue 4 | A05082 | Mar 2018 |

LEGAL NOTICES

Disclaimer

In no event shall Honeywell be liable for any damages or injury of any nature or kind, no matter how caused, that arise from the use of the equipment referred to in this manual.

Strict compliance with the safety procedures set out and referred to in this manual, and extreme care in the use of the equipment, are essential to avoid or minimise the chance of personal injury or damage to the equipment.

The information, figures, illustrations, tables, specifications, and schematics contained in this manual are believed to be correct and accurate as at the date of publication or revision. However, no representation or warranty with respect to such correctness or accuracy is given or implied and Honeywell will not, under any circumstances, be liable to any person or corporation for any loss or damages incurred in connection with the use of this manual.

The information, figures, illustrations, tables, specifications, and schematics contained in this manual are subject to change without notice.

Unauthorised modifications to the gas detection system or its installation are not permitted, as these may give rise to unacceptable health and safety hazards.

By installing this equipment on a computer network, the owner accepts full and unequivocal responsibility for ensuring that it is protected against all cyber threats and illegal tampering during the lifetime of the equipment.

Any software forming part of this equipment should be used only for the purposes for which Honeywell supplied it. The user shall undertake no changes, modifications, conversions, translations into another computer language, or copies (except for a necessary backup copy).

In no event shall Honeywell be liable for any equipment malfunction or damages whatsoever, including (without limitation) incidental, direct, indirect, special, and consequential damages, damages for loss of business profits, business interruption, loss of business information, or other pecuniary loss, resulting from any violation of the above prohibitions.

Warranty

Honeywell Analytics warrants the Touchpoint Pro system against defective parts and workmanship, and will repair or (at its discretion) replace any components that are or may become defective under proper usage within 12 months from the date of commissioning by a Honeywell Analytics approved representative* or 18 months from shipment from Honeywell Analytics, whichever is sooner.

This warranty does not cover consumables, batteries, fuses, normal wear and tear, or damage caused by accident, abuse, improper installation, unauthorized use, modification or repair, ambient environment, poisons, contaminants or abnormal operating conditions.

This warranty does not apply to sensors or components that are covered under separate warranties, or to any 3rd-party cables and components.

Any claim under the Honeywell Analytics Product Warranty must be made within the warranty period and as soon as reasonably practicable after a defect is discovered. Please contact your local Honeywell Analytics Service representative to register your claim.

This is a summary. For full warranty terms please refer to the Honeywell Analytics' General Statement of Limited Product Warranty, which is available on request.

* A Honeywell Analytics approved representative is a qualified person trained or employed by Honeywell Analytics, or a qualified person trained in accordance with this manual.

Copyright Notice

Microsoft, MS and Windows are registered trademarks of Microsoft Corp.

Other brand and product names mentioned in this manual may be trademarks or registered trademarks of their respective companies and are the sole property of their respective holders.

Honeywell is the registered trademark of Honeywell Automation and Control Systems (ACS).

Touchpoint is a registered trademark of Honeywell Analytics (HA).

Find out more at www.honeywellanalytics.com

LEGAL NOTICES

This page deliberately blank.

CONTENTS

Contents

| | | |
|----------|---|-----------|
| 1 | Important Safety Information | 1 |
| 1.1 | International Standards | 1 |
| 1.2 | Warnings..... | 2 |
| 1.3 | Cautions..... | 3 |
| 1.3.1 | Intended Readers | 3 |
| 1.3.2 | Conventions Used | 3 |
| 1.3.3 | TPPR Documentation Suite | 4 |
| 1.3.4 | Document Translations..... | 4 |
| 1.3.5 | Associated Documents | 4 |
| 1.3.6 | How to Use this Document | 4 |
| 1.3.7 | Further Information and Help | 4 |
| 2 | Safety Hazards, Warnings and Cautions..... | 5 |
| 2.1 | Safety..... | 5 |
| 2.1.1 | Warnings and Cautions | 5 |
| 2.1.2 | Safety Hazards | 6 |
| 2.2 | Location and Description of Warning Labels..... | 8 |
| 2.2.1 | Safety Warning Labels..... | 8 |
| 2.2.2 | Equipment Rating Labels (Hazardous Locations)..... | 9 |
| 2.2.3 | Warning Labels..... | 10 |
| 3 | Touchpoint Pro Introduction..... | 11 |
| 3.1 | TPPR Access Levels | 11 |
| 3.2 | TPPR Control System Layout..... | 12 |
| 3.2.1 | Centralised Command and Control Option | 13 |
| 3.2.2 | Distributed Command and Control (Remote Units) Option | 13 |
| 3.3 | TPPR System Key Components..... | 14 |
| 3.3.1 | Enclosures and Racks | 14 |
| 3.3.2 | TPPR Controller User Interfaces | 14 |
| 3.3.3 | SD Card..... | 15 |
| 3.3.4 | USB Port..... | 15 |
| 3.3.5 | PC Configuration Software | 15 |
| 3.3.6 | PC Operating Systems | 15 |
| 3.3.7 | Webserver Software | 15 |
| 3.3.8 | Licences..... | 16 |
| 3.3.9 | TPPR Controller Hardware | 16 |
| 3.3.10 | TPPR Backplane | 17 |
| 3.3.11 | Ring Network | 17 |
| 3.3.12 | TPPR Modules..... | 19 |
| 3.3.13 | Sensor Catalogue | 19 |
| 3.4 | Power Supply Options | 20 |
| 3.4.1 | Power Supply Unit Modules (PSU) | 20 |
| 3.4.2 | Power Redundancy Module (RDN)..... | 21 |

CONTENTS

| | | |
|----------|---|-----------|
| 3.4.3 | DC Uninterruptible Power Supply (DC-UPS) Module | 22 |
| 3.4.4 | Backup Batteries..... | 23 |
| 4 | Configuration Files..... | 25 |
| 4.1 | Viewing and Editing the Configuration | 25 |
| 4.1.1 | To View or Edit the Configuration | 25 |
| 4.2 | To Back Up the Configuration | 26 |
| 4.3 | Restoring the Configuration | 26 |
| 4.4 | Deleting the Configuration | 26 |
| 5 | Normal Day-to-Day Operation | 27 |
| 5.1 | TPPR Controller Touchscreen Interface | 27 |
| 5.2 | TPPR PC Configuration Software Interface | 27 |
| 5.3 | TPPR Webserver Interface | 27 |
| 5.4 | TPPR Safety Function | 28 |
| 5.5 | Touchscreen Operation | 28 |
| 5.5.1 | System Status Screen Alert Icons | 28 |
| 5.5.2 | Active Event History..... | 29 |
| 5.5.3 | Touchscreen Layout | 29 |
| 5.5.4 | Touchscreen Navigation | 30 |
| 5.5.5 | Login Requirements..... | 32 |
| 5.6 | How to Recalibrate the Touchscreen | 32 |
| 5.7 | How to View Input Channels and Input Details | 32 |
| 5.8 | How to View Output Channels | 33 |
| 5.9 | How to View the Trend Graph..... | 34 |
| 5.9.1 | To View the Trend Graph..... | 34 |
| 5.10 | How to View Event History..... | 35 |
| 5.11 | How to View Event Reports | 35 |
| 5.11.1 | How to Generate Reports | 35 |
| 5.11.2 | How to Print Active Events..... | 35 |
| 5.12 | How to Access Diagnostic information..... | 36 |
| 5.13 | Managing the Integral SD Card..... | 36 |
| 5.13.1 | SD Card Purposes..... | 36 |
| 5.13.2 | SD Card Management | 37 |
| 5.13.3 | SD Capacity Reporting | 37 |
| 5.13.4 | How to Check the SD Card Capacity | 37 |
| 5.13.5 | Ejecting the SD Card | 37 |
| 5.13.6 | Replacing an SD Card | 37 |
| 5.14 | Accessing Help | 37 |
| 5.15 | System State Relays..... | 38 |
| 5.15.1 | ROM Output Relays on System Fail | 38 |
| 6 | Alarms, Faults, Warnings and Inhibits | 39 |
| 6.1 | Latching Alarms | 39 |
| 6.2 | STEL / LTEL Alarms | 39 |

CONTENTS

| | | |
|----------|--|-----------|
| 6.2.1 | Using the STEL Alarm | 39 |
| 6.2.2 | Assigning the STEL Alarm to an Output Relay | 40 |
| 6.3 | Rate Alarm..... | 40 |
| 6.4 | Relay Activated Outputs | 40 |
| 6.5 | Sensor Over Range Operation..... | 40 |
| 6.5.1 | Gas Readings | 41 |
| 6.6 | Catalytic Sensor Over Range Operation | 41 |
| 6.7 | Full Scale Exceeded and Over Range Warning Operation | 41 |
| 6.7.1 | Event Status with a Rising Gas Reading | 42 |
| 6.7.2 | Event Status as the Gas Concentration Decreases | 42 |
| 6.7.3 | Special Considerations when using Catalytic Sensors | 43 |
| 6.7.4 | Configuration of Relay Outputs..... | 43 |
| 6.8 | Responding to Alarms, Faults and Warnings..... | 44 |
| 6.8.1 | To View Active Alarms..... | 45 |
| 6.8.2 | To Acknowledge an Active Alarm | 45 |
| 6.8.3 | To Reset a Latched Alarm | 46 |
| 6.9 | Viewing Faults and Warnings..... | 46 |
| 6.9.1 | To View Faults and Warnings | 46 |
| 6.9.2 | To Acknowledge (Accept) a Fault or Warning..... | 47 |
| 6.9.3 | To Reset a Latched Fault or Warning | 47 |
| 6.10 | Inhibiting a Channel | 47 |
| 6.10.1 | How to Inhibit a Channel..... | 47 |
| 6.10.2 | Channel Auto-Inhibits | 48 |
| 7 | Maintenance Procedures..... | 49 |
| 7.1 | Routine Maintenance | 49 |
| 7.2 | Periodic Maintenance | 50 |
| 7.2.1 | Battery Enclosure Maintenance | 50 |
| 7.2.2 | Cable Maintenance..... | 50 |
| 8 | How to Test the TPPR System | 51 |
| 8.1 | Introduction | 51 |
| 8.2 | LED Panel Test..... | 52 |
| 8.3 | Field Inputs Test | 52 |
| 8.4 | Configuration Settings Test..... | 53 |
| 8.4.1 | How to use the Configuration Settings Test Mode | 53 |
| 8.5 | Cause and Effect Test | 54 |
| 8.5.1 | How to use the Cause and Effect Test Mode:..... | 54 |
| 8.6 | Panel Button Test | 55 |
| 8.7 | System Relay Test..... | 55 |
| 8.8 | LCD Screen Test | 56 |
| 8.9 | How to Exercise the Output Relays | 56 |
| 9 | Calibrating Gas Sensors..... | 57 |
| 9.1.1 | Calibration Definitions..... | 57 |

CONTENTS

| | | |
|-----------|--|-----------|
| 9.2 | Calibrating AIM-mV Input Channels..... | 58 |
| 9.3 | Calibrating AIM-mA Input Channel Loops..... | 58 |
| 10 | System Troubleshooting | 59 |
| 10.1 | Observed Problem..... | 59 |
| 10.2 | Other Issues..... | 62 |
| 10.2.1 | Modules Reporting a Fault..... | 62 |
| 11 | Error Codes | 63 |
| 12 | Other Potential Issues | 74 |
| 12.1 | Batteries Fail to Come Online..... | 74 |
| 12.2 | DC-UPS Shows that Batteries are Failing..... | 74 |
| 12.3 | Module Faults | 74 |
| 12.4 | Modules Reporting a Fault..... | 74 |
| 12.5 | Spurious Fault Reporting | 75 |
| 13 | Further Assistance and Training | 76 |
| 14 | EU Declaration of Conformity | 77 |
| 14.1 | Applicable National and International Standards | 77 |
| 14.2 | National and International Certificates for Zone 2 Div. 2..... | 78 |
| 14.3 | European Performance Approval (DEKRA Exam) for Systems | 78 |
| 14.3.1 | Approved Components | 79 |
| 14.3.2 | Special Conditions for Use When Used for Explosion Protection | 80 |
| 14.3.3 | Special Conditions for Use When Used for Measurement of Toxic Gases or Oxygen..... | 80 |
| 14.3.4 | Configuration of Relay Outputs for safety-related switching operations..... | 81 |
| 14.3.5 | Compliance with EN 45544-2 (Toxic Gases)..... | 81 |
| 14.3.6 | Compliance with EN 50104 (Oxygen)..... | 81 |
| 14.4 | Important Notes on Certification..... | 81 |
| 15 | Ordering Information | 82 |
| 15.1 | TPPR System ID Configuration..... | 82 |
| 15.2 | TPPR Components Part Numbers..... | 83 |
| 16 | Disposal of Redundant / Unserviceable Parts | 84 |
| 16.1 | Restriction of Hazardous Substances (RoHS) Directive | 84 |
| 16.2 | Waste Electrical and Electronic Equipment (WEEE) Directive..... | 84 |
| 16.3 | TPPR System Construction | 84 |
| 16.3.1 | TPPR Safe Area Enclosures:..... | 84 |
| 16.3.2 | TPPR Battery Enclosure..... | 84 |
| 16.3.3 | TPPR 19 Inch Rack | 84 |
| 16.3.4 | TPPR I/O Modules..... | 84 |
| 16.3.5 | TPPR Power Supply Units..... | 85 |
| 16.3.6 | TPPR Ring Coupling Module..... | 85 |
| 16.3.7 | TPPR Backplanes..... | 85 |
| 16.3.8 | TPPR Packaging | 85 |
| 17 | Table of Icons | 86 |
| 18 | List of Illustrations | 88 |

CONTENTS

| | |
|-------------------------|----|
| 19 List of Tables | 90 |
|-------------------------|----|

SAFETY

1 Important Safety Information

The Equipment referred to in this manual contains components and assemblies that are each certified for use in a variety of differing environments, and it is the site owner's responsibility to confirm the suitability of the equipment and any associated computer networks prior to its installation and use.

The Equipment assemblies referred to in this manual are collectively certified for use in a gas detection system only. Any other use is not currently certified and is not authorised by the manufacturer.

For installation in Canada and the USA, for both ordinary and hazardous locations, all connections, cabling, overcurrent protection and installations must strictly adhere to both the National Electrical Code (NEC) and the Canadian Electrical Code (CEC).

Check the product rating plate and look for the following marks to ensure that the supplied equipment is suitable for its intended location and purpose:

 Products bearing the CE mark conform to all applicable European Directives as stated on the Honeywell product specific EU Declaration of Conformity.

 Products bearing the CSA mark conform to the requirements for Ordinary Locations, and where marked on components and apparatus, Zone 2 and Division 2 Hazardous Locations.

 Products, components and apparatus bearing the ATEX Explosion Protection mark conform to the requirements for Zone 2 Potentially Explosive Atmospheres.



WARNING

FOR SAFETY REASONS THIS EQUIPMENT MUST BE OPERATED BY QUALIFIED PERSONNEL ONLY. READ AND UNDERSTAND THE INSTRUCTION MANUAL COMPLETELY BEFORE OPERATING OR SERVICING THE EQUIPMENT.



ATTENTION

POUR DES RAISONS DE SÉCURITÉ, CET ÉQUIPEMENT DOIT ÊTRE UTILISÉ, ENTRETENU ET RÉPARÉ UNIQUEMENT PAR UN PERSONNEL QUALIFIÉ. ÉTUDIER LE MANUEL D'INSTRUCTIONS EN ENTIER AVANT D'UTILISER, D'ENTREtenir OU DE RÉPARER L'ÉQUIPEMENT.

1.1 International Standards

All personnel should acquaint themselves with the contents of the following standards before commencing work on gas detection systems:

IEC 60079-29-2, which gives guidance on, and recommended practice for, the selection, installation, safe use and maintenance of electrically operated group II apparatus intended for use in industrial and commercial safety applications for the detection and measurement of flammable gases complying with the requirements of EN 60079-29-1.

IEC 60079-20-1, which gives guidance on material characteristics for gas and vapour classification; test methods and data. It also explains how to convert test and calibration gas (span gas) concentrations from %LFL to %v/v.

EN 45544-4, which gives guidance on electrical apparatus used for the direct detection and direct concentration measurement of toxic gases and vapours and a guide for their selection, installation, use and maintenance.

SAFETY

1.2 Warnings

Read the following Warnings and Cautions before starting any work on the TPPER system.



WARNINGS

1. For safety reasons this equipment must be operated by qualified personnel only. Read and understand the Instruction Manual completely before operating or servicing the equipment.
2. The equipment specified in this manual is only to be installed by the Manufacturer's trained personnel, or by competent persons trained in accordance with the Manufacturer's installation instructions.
3. Installation must be in accordance with the recognized standards of the appropriate authority in the country concerned. Refer to local, national and company regulations.
4. To protect against cyber threats, installation on a computer network must be carried out in collaboration with your Company's IT department or professional IT consultants, and the guidelines and recommendations in the *Honeywell Network Security Guide* should be followed.
5. Do not operate the Touchpoint Pro system or its components outside of their rated operating specification.
6. Touchpoint Pro must not be operated in Oxygen enriched atmospheres, i.e. greater than 25% v/v Oxygen.
7. All equipment containing a User Interface must be suitably protected from direct sunlight and rain.
8. Power Supply Fluctuations are not to exceed DC 18 – 32 V SELV Supply or $\pm 10\%$ of nominal.
9. All versions of Enclosure are electrical Class 1, and must be connected to Protective Earth (Ground).
10. The Touchpoint Pro installation must include a means of isolating or disconnecting the input voltage supply. The isolation or disconnection device must be conveniently located close to the system and be clearly labelled. For an AC mains voltage supply, the isolation or disconnection device must disconnect both the line and neutral poles, but maintain earth (ground) continuity.
11. The Touchpoint Pro input voltage supply must include over-current protection.
12. All cabling must be appropriately rated and approved in accordance with local, national and company regulations, and suitable for the installation. Additionally, cabling must satisfy requirements defined in the manuals of connected field devices, in particular if the field device is certified for use in a hazardous location.
13. All signal cables and interconnections must be shielded and the shields terminated only at the unified earth (ground) bus bar situated inside the enclosure.
14. All conduits and cable armour shall be bonded to protective earth (ground). To avoid ground loops, isolating cable entry glands shall be used at the enclosure end where conduits or armour are earthed at the sensor end.
15. Cable entry glands, blanking plugs, reducers, adaptors and breather devices must be suitably approved and must not reduce the IP rating or protection levels. Items should not be used if there is a high risk of mechanical damage to the equipment or enclosure.
16. Cable gland plates or blanking plates must be installed using the supplied gaskets and metal fixings. Failing to do so will invalidate the IP rating.
17. Access doors and entry points must not be opened when a flammable gas atmosphere is present (Class 1 Div.2, Class 1 Zone 2, and Zone 2 [ATEX]).
18. Access doors and entry points must be kept closed when the system is energised in normal operation.
19. All equipment in this manual is rated to +2000 m (6562 ft.) altitude maximum.
20. Touchpoint Pro systems may contain hazardous live terminals. Appropriate precautions should be taken during operation, installation, and maintenance and servicing. Specifically, operators must have appropriate training and experience to be aware of the hazards to which they may be exposed, and of measures to minimise risk to themselves or other people.
21. The protection provided by the equipment may be impaired if the equipment is used in a manner not specified or authorised by the manufacturer. This includes being connected to an insecure TCP/IP network.
22. Be aware that extended exposure of a sensor element to certain concentrations of combustible gases and air can introduce stress to the element that may seriously affect its performance, and therefore recalibration should be carried out or the sensor replaced, or both, after an alarm due to an indication of a high concentration.
23. Risk Assessments should be carried out and alternative safety arrangements should be put in place BEFORE beginning any servicing or maintenance.

SAFETY

1.3 Cautions



CAUTIONS

1. The USB Device port is for Maintenance use only. End users shall use only the USB Host port with a USB Flash drive, and backup / restore / upgrades shall only be performed with the system in a safe (i.e. inhibited) mode.
2. Touchpoint Pro power supply units, Ring Coupling Modules and Input / Output Modules have no user serviceable parts. In the unlikely event of a failure, the power supply unit or module must be replaced using only manufacturer supplied parts.
3. Do not use sharp objects to operate the Touchscreen as this could irreparably damage the User Interface and adversely affect its IP rating.
4. Use only soft, damp cloths or screen wipes to clean the Touchpoint Pro. Do not use solvents or abrasives as they will damage the User Interface.
5. Once commissioned, Touchpoint Pro is intended for continuous operation.

1.3.1 Intended Readers

This Manual should be read by everyone who operates or monitors the TPPR gas detection system. In addition this manual may be used to train people who operate or monitor the TPPR gas detection system.

Only personnel who have been fully trained by Honeywell are authorised to Install, Set-up, Commission, Service, Test, Repair, or Recondition Honeywell gas detection systems.



IMPORTANT

Personnel, who work on, or in the area of, the Touchpoint Pro Gas detection system must be made aware of *Chapter 2 – Safety Hazards, Warnings and Cautions*.
Before unpacking the system, please read the documentation that accompanies it.

1.3.2 Conventions Used

The following conventions are used in this manual:

- ‘**TPPR**’ refers to the Touchpoint Pro Gas Detection System.
- ‘**Start up**’ refers to the action of switching on the system ready for use.
- ‘**Power Cycle**’ refers to cycling the power off and then on again.
- ‘**Boot up**’ refers to the action of starting the software from cold.
- ‘**Reboot**’ refers to shutting down and restarting the software without interrupting the power supply.

SAFETY

1.3.3 TPPR Documentation Suite

The TPPR documentation is supplied on CD-ROM with new systems, and is available to download from the Honeywell Analytics website, whose address is on the back cover.

The downloadable TPPR documentation suite consists of:

- Touchpoint Pro Technical Handbook
- Touchpoint Pro Operating Manual (this document)
- PC Configuration Software Operating Guide
- Webserver Software Operating Guide
- Touchpoint Pro Safety Manual
- Touchpoint Pro Security Guide

1.3.4 Document Translations

TPPR Technical documents are available in English only, but this document is available in:

- Deutsch (DE)
- English (EN)
- Español (ES)
- Français (FR)
- Italiano (IT)
- Nederlands (NL)
- русский (RU)

1.3.5 Associated Documents

TPPR documents should be read in conjunction with 3rd-Party or ancillary component and sensor documentation.

1.3.6 How to Use this Document

This document is not designed to be read 'end-to-end'. Rather it is intended to be used as an authoritative reference work and source of safety information and operational procedures. As such it is organised into logical sections and chapters that allow all levels of reader to quickly access the required information.

This document is organised so that individual sections, chapters or pages can be copied or printed as a quick reference source. All new chapters start on an odd facing page to allow them to 'stand-alone' when printed, and some end pages are deliberately blank for the same reason.

It is strongly recommended that the hyperlinked Contents, Figures, and Table lists, and the PDF bookmark tool, are used for easy navigation.

1.3.7 Further Information and Help

Contact Honeywell Analytics Technical Support for advice if you notice any conflicts between this and other documents.

Contact Honeywell Analytics Sales Support for a list of TPPR-compatible sensors, filters, test gases or other components.

The Honeywell contact details are on the back page of this document.

SAFETY

2 Safety Hazards, Warnings and Cautions

2.1 Safety

Incorrect set-up, maintenance, operation or modification of the Touchpoint Pro gas detection system *or its installation* may constitute a serious hazard to the health and safety of personnel and their environment. It is therefore imperative that the contents of this chapter are thoroughly understood by everyone who has access to the gas detection system or its associated equipment.

When properly installed, fully-enclosed gas detection systems are rated IP65.

Standard systems may be installed in a Pollution Degree 2 (i.e. laboratory, office or control room) or Pollution Degree 3 (i.e. unheated boiler room) environment as defined by IEC/UL/EN 61010–1: Safety requirements for electrical equipment for measurement, control and laboratory use.

In all cases, several hazards may be present when operating or servicing the equipment and extreme caution must be exercised at all times. The hazards that may be encountered include:

- Class 1 electrical hazards (AC 110/220 V, DC 18–32 V)
- Mechanical hazards (Heavy components, swinging access doors)
- Environmental hazards (toxic atmospheres)
- Fire and Ignition hazards (Touchpoint Pro is **not** ATEX/IECEX Zone 1 certified, and cannot be used in flammable atmospheres, or where oxygen concentrations >25% v/v O₂)

2.1.1 Warnings and Cautions

Safety of this equipment is reinforced by the use of safety labels that are fixed to the equipment in a visible manner. The type of safety labels used and their location is detailed in this chapter. In addition, specific hazards are detailed throughout this manual.

The degree of seriousness of a hazard is indicated in this manual by the use of the following signal words (in red) accompanied by a suitable hazard symbol:

DANGER

Indicates an imminent hazard that, if not avoided, is **extremely likely to result** in death or serious injury.

WARNING

Indicates a potentially hazardous situation that, if not avoided, **could result** in death or serious injury.

CAUTION

Indicates a potentially hazardous situation that, if not avoided, **may result** in minor or moderate injury. It is also used to alert the user against unsafe working practices and potential damage to equipment.

SAFETY

2.1.2 Safety Hazards

The following specific hazards are associated with the use of this equipment:



DANGER – IGNITION HAZARD

The Touchpoint Pro Controller is NOT ATEX/IECEx safe, and it may only be installed in safe areas where there are no flammable atmospheres, and no oxygen concentrations >25 % v/v O₂.



DANGER – IGNITION HAZARD

The Touchpoint Pro range includes a wall mounted enclosure that is certified as ATEX/IECEx Zone 2, Class I Div. 2 and Class I (Zone 2) safe, but this enclosure can only be installed as a remote unit.

ATEX certified components may be used within the Touchpoint Pro and these bear the ATEX imprint shown to the left.



WARNING – LETHAL VOLTAGE PRESENT

All power supplies must be hard wired and must include a circuit breaker (RCD / RCCB), and (close by and unobstructed) a means of manually isolating and locking out the power supply without breaking the true earth (ground) connection.

Removable plug and socket connection is not permitted under any circumstance.



WARNING – LETHAL VOLTAGE PRESENT

Lethal voltage may be present in this equipment when electrical power is applied. There is a danger of death or injury from electrical shock. Isolate power before opening electrical access panels. Ensure residual current is fully discharged before touching live terminals.



WARNING – LETHAL VOLTAGE PRESENT

Lethal voltage may be present both internally and externally to the system.

All installations, including cabinets, racks and remote units, must be connected to true earth, and must be capable of staying earthed (grounded) when the power supply is interrupted.

The Protective Earth (Ground) symbol is shown on the left, and it *always* has a green background.

Do not confuse it with the chassis earth symbol shown below it.



WARNING – TOXIC WASTE AND HARMFUL BY-PRODUCTS

Toxic waste and harmful by-products may accumulate within parts of the system. Suitable respiratory, eye and skin protection should be worn when servicing these items. Stringent industrial hygiene precautions should also be taken. Do not allow non-essential personnel into the work area.

The Touchpoint Pro system and/or its sensors may become contaminated by the ambient environment in which it or they are used. It is the Customer's sole responsibility to ensure that all appropriate safety precautions are taken before handling any components or transferring them to any other party.

SAFETY

Safety Hazards (continued)



WARNING – EYE HAZARD

The Touchpoint Pro system may contain sealed lead-acid batteries that may pose an eye hazard if the batteries have become damaged or pressurised. Always wear suitable eye protection when handling the UPS or batteries, or when clearing up chemical spills.



CAUTION – CORROSIVE

This equipment may contain batteries containing corrosive substances that may pose a health or environmental hazard if improperly handled or carelessly disposed of.



CAUTION – HEALTH AND ENVIRONMENTAL HAZARDS

This equipment contains a number of potentially toxic substances that may pose a health or environmental hazard if exposed to very high temperatures, VOCs or corrosives, or if improperly handled or carelessly disposed of.



CAUTION – RISK OF PERMANENT EYE AND BODY DAMAGE

Always wear suitable eye protection and PPE when installing or removing the Touchpoint Pro system, or any of its components.

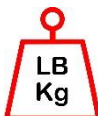

CAUTION – RISK OF INJURY AND DAMAGE

Touchpoint Pro enclosures are heavy and may become unstable when moved. Always wear PPE and ensure that mechanical means and sufficient personnel are available to assist when moving or handling these items.

Contact your Honeywell authorised representative if you need further advice on any of the above.

SAFETY

2.2 Location and Description of Warning Labels

2.2.1 Safety Warning Labels

Warning labels are mounted in specified locations on the equipment. This is to indicate conditions under which the user could be subjected to electrical or other hazards.



Figure 1. Electrical Warning Label 1



Figure 2. Electrical Warning Label 2



Figure 3. Protective Earth (Ground) Point



Figure 4. Equipment Earth (Ground) Point

Note: Earth (Ground) Location Point labels are used inside the system and are not normally visible to the operator.

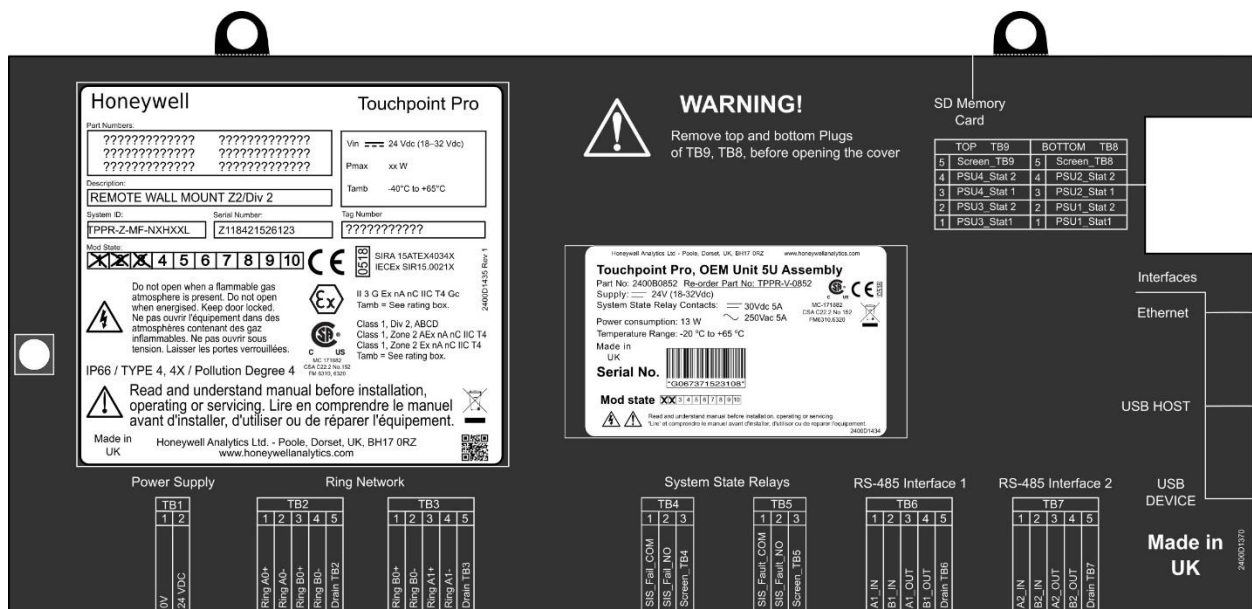

Figure 5. Controller Rear Cover with Example Labels

See next page for further information.

SAFETY

2.2.2 Equipment Rating Labels (Hazardous Locations)

The following labels are fixed in prominent positions on the enclosure and on relevant modules. It is the user's responsibility to check individual rating plates before installation and to ensure that specifications are not exceeded during operation. Exceeding the approved ratings invalidates product certification and the manufacturers' warranties.

Some early and OEM Controllers may not have the label shown in Fig. 5, but will have a label similar to the one in Fig. 6.

| Key | |
|-----|--|
| 1 | Manufacturer |
| 2 | Part Numbers |
| 3 | Description |
| 4 | ID and Serial Number |
| 5 | Modification State |
| 6 | Safety Warnings |
| 7 | Ingress Ratings |
| 8 | Manufacturer Details |
| 9 | Equipment Title |
| 10 | Limits for Voltage / Power / T _{amb} |
| 11 | CE Mark and Notified Body for Production Supervision |
| 12 | SIRA ATEX / IECEx Certificate Numbers |
| 13 | ATEX / IECEx Hazardous Area Certification Details |
| 14 | US/Canadian Hazardous Location and Zone Certification Details |
| 15 | CSA Monogram Canada and USA Certified |
| 16 | Manufacturer's Master Contract Number and Canadian / US Performance Identification |

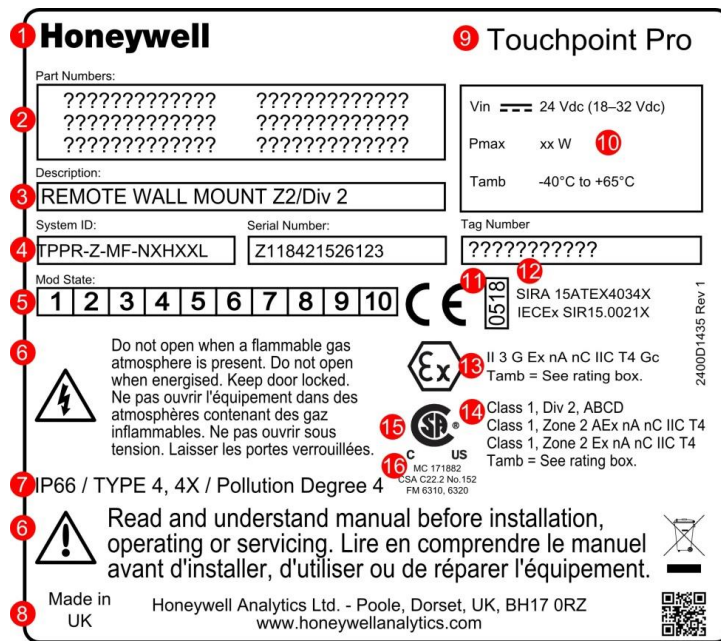

Figure 6. Example of a Typical System Rating Label

Note: The CE mark and Notified Body number 0518 shown on product labels does not apply to Type 'n' approval.



Figure 7. Typical TPPR Product Label

Note: Similar labels appear on the Modules and the Backplanes.

SAFETY

2.2.3 Warning Labels

The following symbols may be found on product labels and on the backup batteries:



Figure 8. Keep Children Away



Figure 9. No Naked Flames



Figure 10. Use Caution

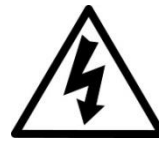

Figure 11. Electrical Hazard



Figure 12. Read The Instruction Manual



Figure 13. Wear Eye Protection



Figure 14. Hazardous Waste
(Pb = Lead)



Figure 15. Recycle Only

INTRODUCTION

3 Touchpoint Pro Introduction

Touchpoint Pro (TPPR) is a Command and Control System designed for the Honeywell Analytics' (and third party) range of fixed sensors and detectors. It provides constant sensor monitoring with automatic alarm response and notification. Its alarm levels and responses are fully customisable and all events and errors are logged on a removable SD card for easy archiving.

TPPR is certified to monitor hazardous areas such as Zone 2 Div. 2 via remote Z2D2 enclosures.

TPPR can be used indoors or outdoors, in pollution degrees 2 to 4, and up to IP66, depending on the enclosure that is used.

In addition it can be securely networked and either controlled or monitored via a secure network connection and the Honeywell PC Configuration software or via the secure Honeywell Webserver browser interface.

Note: Both access methods are optional licensed extras. Please visit the Honeywell website for further information or to download the Operating Instructions.

3.1 TPPR Access Levels

The table below details the access levels for the Local User Interface (UI). Broadly speaking, an **Administrator** can commission modules and configure channels, an **Engineer** can edit channel configuration and do calibrations and testing, and an **Operator** can acknowledge and reset events during normal day-to-day operation. Other users can view current and historical events and trend data, and generate reports.

TPPR is supplied with a default **Administrator** level account. For security reasons this password will be attached to the system Touchscreen. When the system is configured, at least one new **Administrator** account should be created. The default **Administrator** should then log out and then log back in as the new **Administrator**, and should then delete the default **Administrator** account to prevent unauthorized access. The **Administrator** can create other users with **Administrator** level access or lower and the Maintenance **Engineer** can create users with **Engineer** level access or lower.

Note: Forgotten or deleted passwords cannot be recovered so it is advisable to keep a copy of the master password in a secure place or have two **Administrator** accounts.

Authorised users can carry out the following tasks:

Key: Yes ●, No ○ Read only ■ Engineer and Operator ◆

| Task | Administrator | Engineer | Operator |
|---|---------------|----------|----------|
| Basic System Setup | ● | ● | ○ |
| Change Language | ● | ● | ○ |
| Change My Password | ● | ● | ○ |
| Configuring Channels | ● | ● | ○ |
| Configuring Modules | ● | ● | ○ |
| Configuring System | ● | ● | ○ |
| Diagnostics | ● | ● | ○ |
| Help / User Guides | ● | ● | ● |
| Licence Management | ● | ◆ | ○ |
| User Management | ● | ● | ■ |
| View and accept and reset System Events | ● | ● | ● |
| Generate Reports | ● | ● | ● |

Table 1. TPPR Access Levels

Note: Only **Administrators** can end another user's active session.

Note: For security reasons some of these tasks are unavailable through PC Configuration and Webserver software. Refer to the appropriate User Manual for more information.

Note: TPPR's ability to Accept and Reset events can be restricted to authorised users by changing the software settings. However, remote switches cannot be restricted through software so alternative switch protection methods should be used where required.

INTRODUCTION

3.2 TPPR Control System Layout

The TPPR Control system can be built from just four main building blocks:

1. One Controller module with colour LCD touch screen User Interface
2. One backplane power and communications rail (per enclosure or rack)
3. Power Supply modules (AC/DC, DC-UPS, Redundancy, Backup Battery)
4. Plug-in Input / Output (I/O) modules (mV, mA, AIM, DIM, ROM, Modbus)

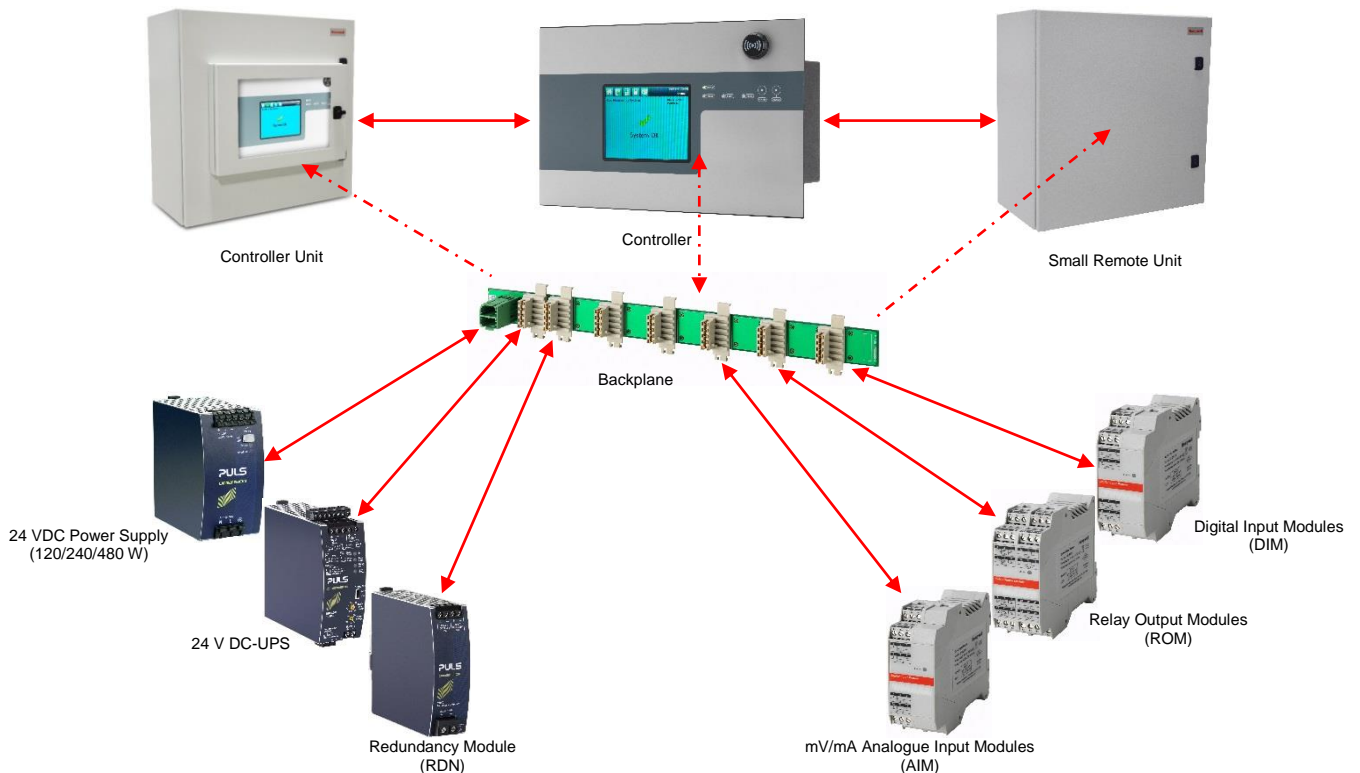

Figure 16. TPPR Building Blocks

The illustration above shows wall mounted units but rack mounted and floor standing units use the same building blocks. Enclosures can also hold multiple backplanes to allow for future system expansion.

INTRODUCTION

3.2.1 Centralised Command and Control Option

TPPR can be installed as part of a centralised cabling system. With a centralised system, the field devices are individually cabled back to the Controller and the field devices' distance from the controller is limited only by the cable resistance and whether or not power boosters are used.

3.2.2 Distributed Command and Control (Remote Units) Option

TPPR can be installed as part of a distributed cabling system. In a distributed architecture, the field devices are connected via short cable runs to TPPR Remote units, which are connected back to the controller by the Ring Network.

Remote units can be located up to 1 km (cable length) from the TPPR Controller or from each other, with a maximum cable loop of 3 km for the complete system. The only connection required between the Controller and the Remote units is the shielded network cable itself.

The TPPR Remote unit can be housed in any of the standard Enclosures, a 19" 5U rack, or a suitable 3rd-party enclosure. They do not need a Controller but they do require their own power supplies.

Note: Standard Remote Units can be sited in safe areas to monitor and control devices sited in hazardous areas. You should comply with all relevant legislation and you should follow the field device manufacturer's installation and use instructions.



WARNING

You can install a Zone 2 Remote unit in Zone 2 to monitor sensors in ATEX Zone 1 provided that you use appropriate barriers and armoured conduits, and that you follow all national and international cabling regulations.

The diagram below shows an example of a typical distributed setup showing both safe zone and zone 2 remote units.

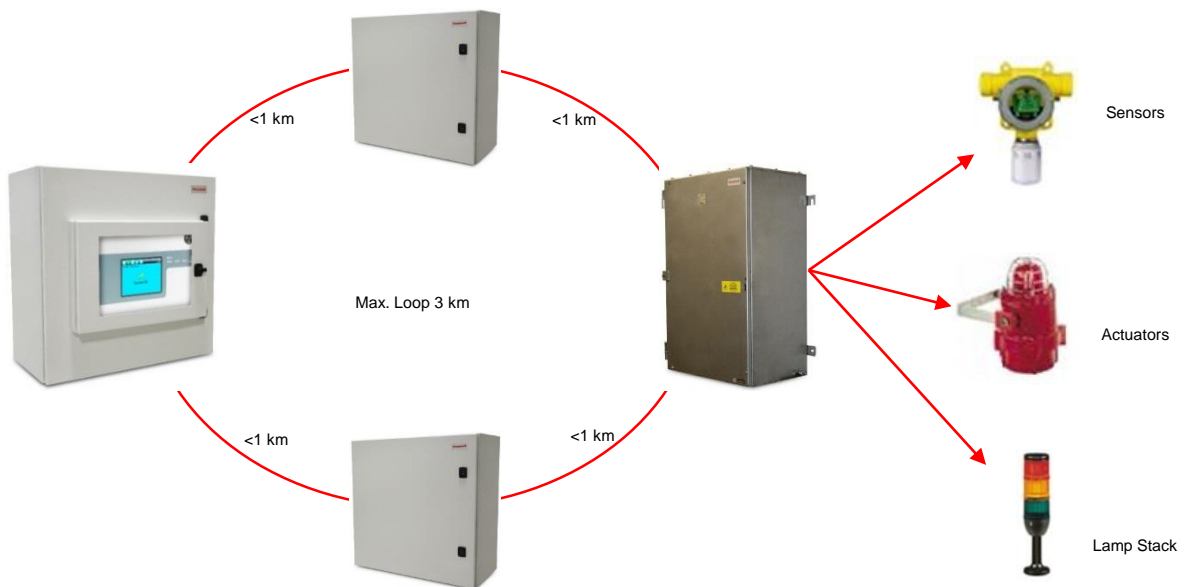

Figure 17. TPPR Controller with Remote Units and Field Devices

INTRODUCTION

3.3 TPR System Key Components

3.3.1 Enclosures and Racks

TPPR can be mounted in various sizes of floor or wall mounted enclosures, or on 19" 5U racks. The floor mounted enclosures can be unventilated, naturally ventilated, or force ventilated. The fully sealed wall mounted enclosures can hold a controller or can be a remote terminal without a controller.

If using a 19" rack, the OEM or installer must ensure the installation is at least IP20 / Type 1 / Class 1 (grounded) to mitigate the risk of electrical shock.



Figure 18. TPPR Enclosures

3.3.2 TPPR Controller User Interfaces

The TPPR Controller is covered with a protective membrane and houses the touch screen user interface (UI), the alarm buzzer, the Accept and Reset buttons, and coloured LEDs for Power, Alarm, Fault, and Inhibit.

The controller has four access methods:

- Control Panel touch screen for normal system operation, maintenance and configuration
- PC Configuration Software (optional licences) for secure maintenance and configuration over a VPN or cable
- Webserver (optional licences) allows up to 5 people to securely view events and carry out basic system operation via an Ethernet connection or the Internet
- Modbus option

Internal System Interfaces consist of:

- Two master relays that signal System Failure and System Fault
- Connections for one SD Card and one USB drive
- 10/100 Mbps Ethernet connection (for networked interfacing)
- Optional dual RS 485 Modbus RTU interface

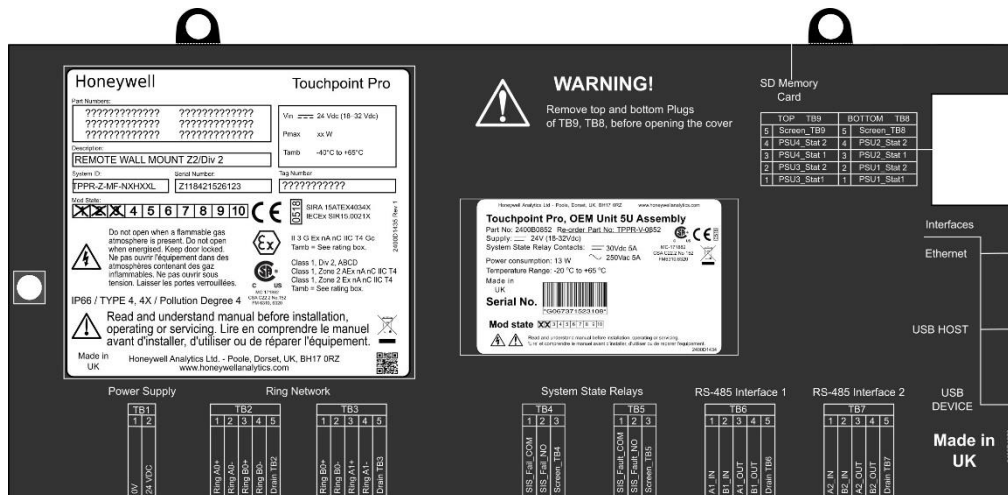

Figure 19. TPPR Controller Cover with Connection Map

INTRODUCTION

3.3.3 SD Card

TPPR is supplied with an installed 4GB SD card, which users may replace with a larger capacity if desired.

The SD card is used to store the event history of the system. TPPR logs all events and all changes to input readings.

Note: The SD Card should remain inserted during normal system operation as the motherboard has limited data storage capacity.

3.3.4 USB Port

The **USB Host** port allows users to save reports, backup and restore configuration.

Note: USB devices must be formatted to **FAT32** only; other file systems are not supported and will not work.

Note: The USB device is intended for maintenance and support operations only, and should be removed for normal use.

3.3.5 PC Configuration Software

This optional (downloadable) licensed software allows authorised users to configure some TPPR settings by using a remote PC over an Ethernet connection. This is more efficient as you can use a larger screen and keyboard.

More information is available in a separate PC Configuration Operating Manual.

3.3.6 PC Operating Systems

Windows 7 is supported for use with PC Configuration software.



CAUTION

Honeywell will not be held liable for any loss or damage caused by any security breach, no matter how caused.
Windows XP is considered a high security risk and is not recommended.

3.3.7 Webserver Software

This optional (pre-installed) licensed software allows users to remotely view live status, and analyse event history. Authorised users can also acknowledge, inhibit and reset I/O channels.

The Webserver supports up to 5 concurrent web clients. More than 5 clients can connect but performance may degrade.

More information is available in a separate Webserver Operating Manual.

3.3.7.1 Supported Web Browsers

TPPR software is compatible with most current web browsers.

INTRODUCTION

3.3.8 Licences

The TPPR controller software does not require a licence.

Please contact your local Honeywell supplier or distributor to obtain licences for the optional PC Configuration and Webserver options.

Refer to the PC Configuration or Webserver User Guides for details on installing and managing licences.

TPPR will notify you shortly before the expiry of your current PC Configuration or Webserver licence. Licence expiry does not affect local operation using the local controller's interface.



CAUTION

Always follow the correct procedure to remove/suspend/reinstall a licence if your system software or firmware is going to be updated or repaired. Full details are contained in the PC Configuration and Webserver User Manuals.

3.3.9 TPPR Controller Hardware

Internally the Controller houses the Control Centre Board (CCB) and the Communications Board (COB). It also contains an SD Card slot, USB ports and an Ethernet / Printer port.

The CCB handles all functions related to the safety system operation, the Ring network, the LED indicators and buttons on the front panel, and the master system state relays. An optional backup CCB is available for multiple redundancy specifications.

The COB handles the remaining user interfaces (UI) – Touchscreen, bus output and the SD, USB and Ethernet ports.

The Communication Board is completely independent from the Safety Function of the system.



Figure 20. TPPR Controller

INTRODUCTION

3.3.10 TPR Backplane

The TPR Backplane is the power and information highway to which all of the TPR modules are attached. There can be several backplanes in larger units, and they are installed within the DIN rail to which the modules are clipped.

The Backplane is available in four lengths (270 mm, 350 mm, 430 mm, 480 mm) to suit 5, 7, 9 or 10 I/O modules respectively, but the choice may be restricted by the size of the selected power supply option and the need to maintain adequate cooling space between modules.

Note: The DIN rail is 430 mm for a standard enclosure or 487 mm for the wide enclosure (10 x I/O) option.

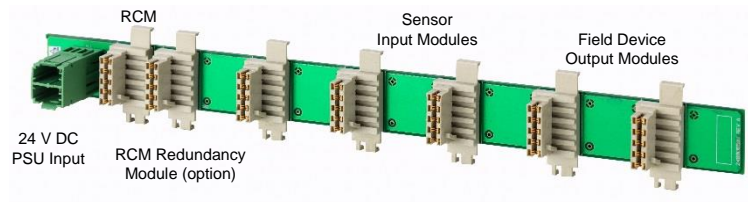

Figure 21. TPR Backplane

The Power Supply Unit (PSU) plugs into the green socket on the left hand side of the Backplane PCB, and it supplies power to the modules via the white connectors. The Ring Coupling Module (RCM) normally sits next to the Power Connector and handles all of the bi-directional communication between the CCB and the modules, again via the white connectors.

3.3.11 Ring Network

The Ring Coupling Module (RCM) and Input / Output (I/O) modules connect to a dual ring circuit so that they can communicate with the CCB through each other and through the RCM.

This enables fail-safe redundancy because, if one addressable module fails and interrupts the primary circuit, the addressable modules on either side of it can still communicate with the CCB via the backup ring circuit (see diagram below), and the CCB can identify which module has failed by knowing which addressable modules are still active.

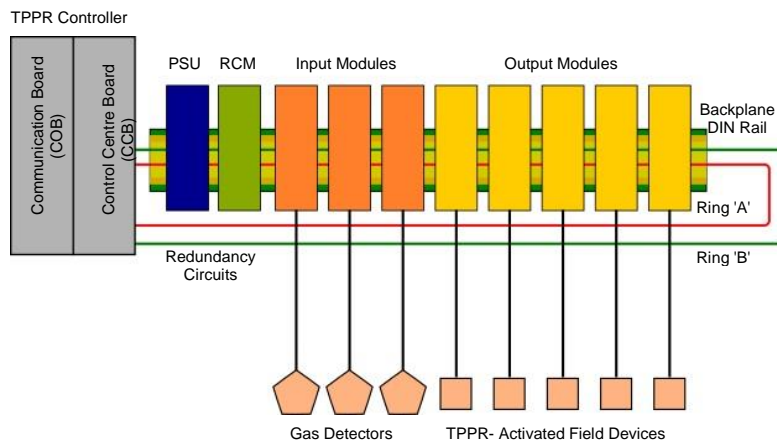

Figure 22. TPR Controller Typical Schematic

INTRODUCTION

For single cabinet installations, the Ring Network runs directly between the RCM and the Control Module.

For Remote units, the network runs additionally over data cable between the Controller and all of the backplanes in the system.

The Ring Network is the only communication link required between the CCB and Remote Units (which have their own backplanes, PSU and modules, but no Control Module).

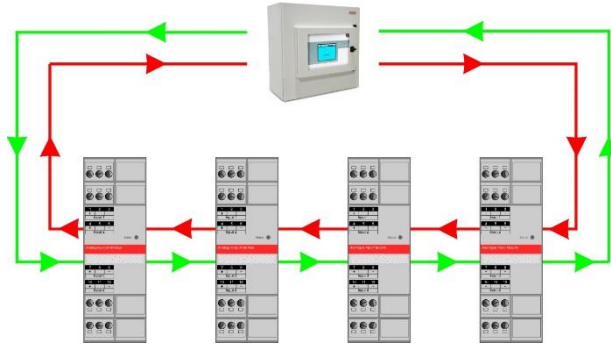

Figure 23. Example Ring Circuit

INTRODUCTION

3.3.12 TPR Modules

TPPR is of modular construction so it can be easily expanded if required. The quantity and mix of I/O modules is optional and expandable.

- Power Supply Unit (PSU) modules accept AC 120 – 240 V at 50/60 Hz single phase and are available in three power outputs: 24 VDC @ 120, 240 or 480 W.
- The optional DC-UPS is an uninterruptible DC power supply that links to and charges the optional 2 x 12 V Sealed Lead Acid backup batteries.
- The optional Redundancy Module (RDN) can control two DC 20 A power inputs. If one input supply fails, the Redundancy Module will switch over to the other, maintaining the DC output. Alarm relays will open if one of the input supplies fails.
- The Ring Coupling Module (RCM) enables fail-safe bi-directional (ring network) communication between modules and the controller. An RCM is required for each backplane in the system.

Various types of I/O modules are available, each containing four channels. A single TPR system can contain up to 16 input modules offering 64 input channels and up to 32 output modules offering 128 output channels.

| Title | Description |
|--|--|
| Analogue Input Module 4–20 mA (AIM mA) | 4-channel Analogue Input Module for 2 or 3 wire 4-20mA sensor signals |
| Analogue Input Module mV Bridge (AIM mV) | 4-channel Module for mV-Bridge signals; supports up to 4 catalytic bead flammable gas sensors |
| Digital Input Module (DIM) | 4-channel Module for switched input devices such as manually operated push buttons. Can also be used for remote access to alarm acknowledge, reset and output inhibit inputs |
| Relay Output Module (ROM) | 4-channel Module incorporating qty 4 SPCO (NO/NC) relays; suitable to activate field mounted external alarms, actuators, drenching or shutter systems, or to de-activate magnetic exit controls etc. |

Table 2. TPR Module Types



Figure 24. TPR Module Types

3.3.13 Sensor Catalogue

The TPR Controller is pre-loaded with an updatable sensor catalogue that lists all of Honeywell Analytics' current gas sensors, each with a full default configuration setting that can be loaded when commissioning the Input modules. The full configuration can be viewed afterwards, and individual parameters changed if desired.

The full procedure is explained in the *TPPR Technical Handbook, Ch.7 Software Setup and Commissioning*.

INTRODUCTION

3.4 Power Supply Options

TPPR can be supplied from an AC 110/240 V Single Phase industrial supply via the optional Power Supply (PSU) Modules, or from a direct DC 24 V power supply, or from optional 24 VDC backup batteries via the DC Uninterrupted Power Supply module (DC-UPS).

When specifying power supplies, you should consider cabinet internal temperatures and cooling. In addition, power supplies should be rated to allow for current surges and peaks. Contact your Honeywell representative for advice.



WARNING

AC power supplies must have a permanent connection to a protective earth, according to local regulations.

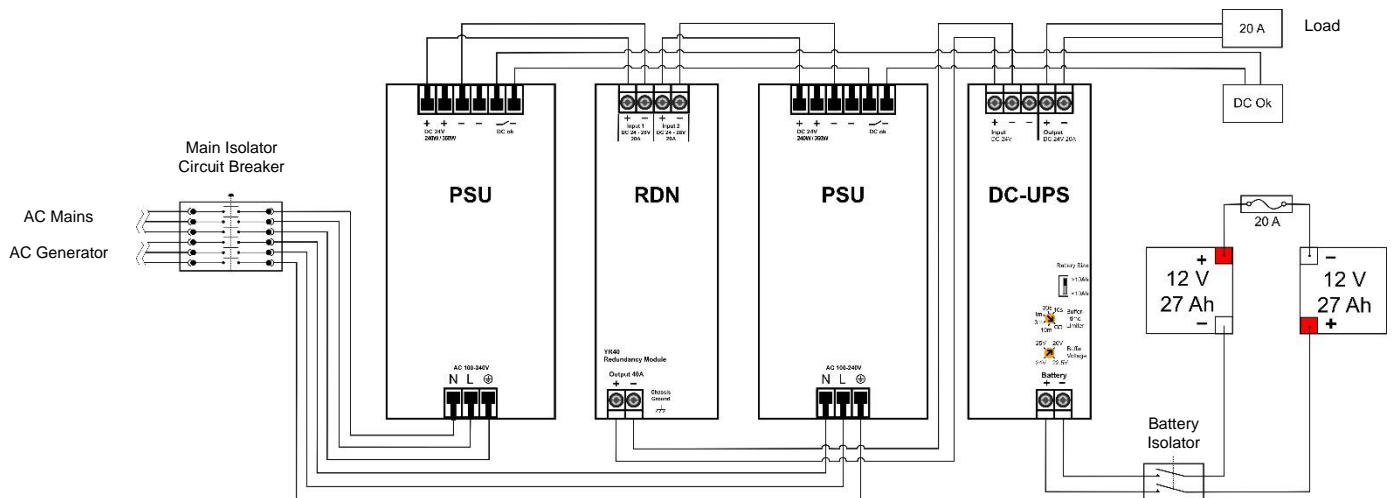

Figure 25. Typical Power Supply Setup

A full description of the available module types is given in the following sections.

3.4.1 Power Supply Unit Modules (PSU)

The TPPR System can be equipped with PSU modules of different capacity, depending on the number of I/O modules being used. The power supplies are mounted to the DIN-Rail and are available in the following ratings:

- 120/180 W, 24 – 28 VDC (5 A @ DC 24 V)
- 240/360 W, 24 – 28 VDC (10 A @ DC 24 V)
- 480/720 W, 24 – 28 VDC (20 A @ DC 24 V)

The power supplies have a 'DC Ok' status output that can be used to give a fault warning on failure.



Figure 26. Choice of PSU Size (120 W / 240 W / 480 W)

INTRODUCTION

| Terminal | Purpose |
|---|---------------------------|
| N | ~ AC 110/240 V Neutral In |
| L | ~ AC 110/240 V Line In |
|  | Protective Earth (Ground) |
| + | ⋮ DC 24 – 28 +V Output 1 |
| + | ⋮ DC 24 – 28 +V Output 2 |
| - | ⋮ DC -V Output 1 |
| - | ⋮ DC -V Output 2 |
| DC OK | ⋮ Relay Contacts 1 & 2 |

Table 3. PSU Terminal Allocation

3.4.2 Power Redundancy Module (RDN)

The RDN is an optional power supply backup system that can be installed with a second PSU to offer dual power supply redundancy. Often the Mains supply will be connected to the first PSU and a stand-by generator connected to the second PSU. The RDN will take power from either input and output it as a single source. See diagram below for cabling details.

Note: The RDN Output can also provide further redundancies via an optional battery backup and DC Uninterruptible Power Supply (DC-UPS) module.

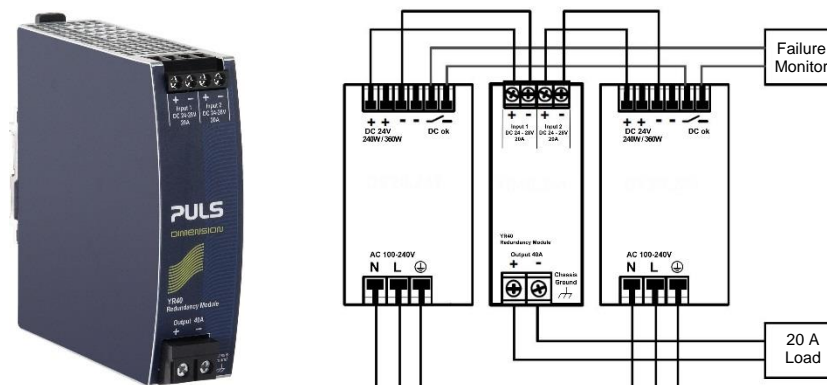

Figure 27. Power Redundancy Module Operation

INTRODUCTION

3.4.3 DC Uninterruptible Power Supply (DC-UPS) Module

The DC-UPS Module can be used with the separate and optional TPPR Battery Enclosure to provide continuous and uninterrupted power to the TPPR in the event of an external power failure.

The DC-UPS is adjustable for buffer time and buffer voltage, and carries red, yellow and green status LEDs and descriptions that show your backup battery status (see tables below).

Note: The DC-UPS Module Buffer Voltage should be set at 26 VDC to ensure optimum battery charging, and the Buffer-time Limiter should usually be set to ∞ (see circled area on the figure below).

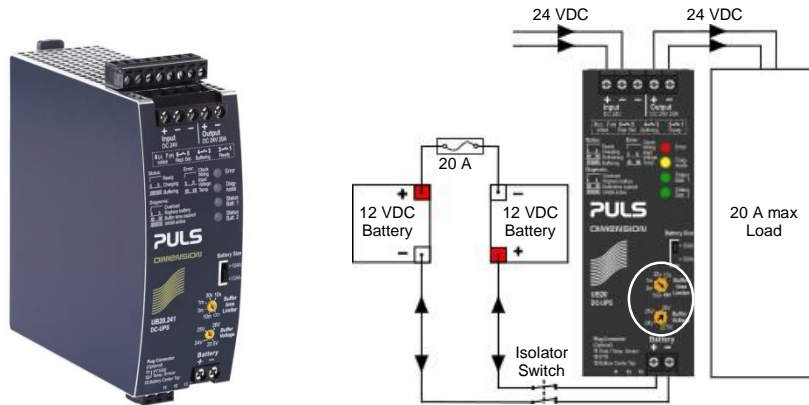

Figure 28. DC-UPS and Battery Configuration

The DC-UPS terminals are as follows:

| DC-UPS Terminal | Purpose |
|-----------------|-----------------------------------|
| Input + | +24 VDC input from UPS |
| Input – | –24 VDC input from UPS |
| Input – | –24 VDC input from UPS (spare) |
| Output + | +24 VDC output to 20 A (max) Load |
| Output – | –24 VDC output to 20 A (max) Load |
| Battery + | +24 VDC Battery in/out |
| Battery – | +24 VDC Battery in/out |

Table 4. DC-UPS Primary Terminal Allocation

The DC-UPS also has Normally Open (NO) relay terminals that can be used for external repeaters such as a lamp stack or alarm buzzer, as shown in the table below:

| DC-UPS Terminal | Purpose |
|-----------------|---|
| 1 & 2 | Ready relay: Closed when all is Ok (green) |
| 3 & 4 | Buffering relay: Closed when batteries are supplying power (yellow or buzzer) |
| 5 & 6 | Replace Battery relay: Closed when batteries fail load test (red or buzzer) |
| 7 & 8 | Do not use as Inhibit belongs to the Controller only |
| 11 – 13 | Not normally used |

Table 5. DC-UPS Secondary Terminal Allocation

INTRODUCTION





| LED Flash | Green Status LEDs | Yellow Diagnosis LED | Red Error LED |
|---|---|--|---|
|  | Steady means DCUPS ready | Steady means Power Overload | Steady means Check the wiring |
|  | Single flash means Charging | Single flash means Replace Batteries | Single flash means Check Input voltage |
|  | Double flash means Refreshing | Double flash means Buffer time expired | Double flash means Over Temperature |
|  | Continuous flashing means Buffering | Continuous flashing means Inhibit Active | — |

Table 6. DC-UPS LED Meanings

3.4.4 Backup Batteries

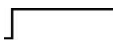
The optional Battery Enclosure contains two rechargeable 12 V batteries wired in series to give a nominal 24 VDC supply. The batteries can be either 12 Ah or 27 Ah and they are overload-protected by a 20 A fast acting inline cartridge fuse.

A new set of 12 / 27 Ah batteries should supply 22.5 V at 20 A for up to 16.75 / 32 minutes respectively, depending on the connected load. However, you should be aware that all batteries deteriorate over time, and Honeywell recommend that you check and replace them regularly to ensure optimum performance in an emergency.

Note: Always switch the Battery Isolator switch to **Off** before carrying out any work on the battery circuit, and ensure it is **On** when work is completed.

The 12V monobloc batteries are Valve-Regulated Lead Acid (VRLA) Absorbed Glass Mat (AGM) batteries that:

- Are optimized for discharge (buffer) times of up to 20 hours @ 3 A.
- Have a 5 year design life in float operation in temperature controlled environments.
- Have VRLA AGM and gas recombination technology with 99% internal recombination.
- Are non-spillable and maintenance free.
- Are non-hazardous when packaged for air/sea/rail/road transportation.
- Are 100% recyclable.



| 12 / 27 Ah Battery (pair) | Stand-by Use |
|---------------------------|--|
| Charge Voltage (max) | 27 V |
| Input Current | 3 A |
| Max Output Current | 20 A |
| Max Load | 30 A <4 Sec. |
| Fuse type (inline) | 20 A Fast Acting Tube |
| Current Limit Protection | 20 A Double-pole Circuit Breaker / Isolator, |
| Weight 12 Ah | 3.75 kg (ea.) |
| Weight 27 Ah | 8.5 kg (ea.) |



Table 7. Backup Battery Details

INTRODUCTION

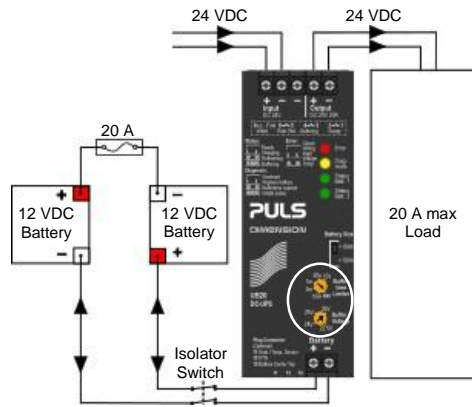

Figure 29. Battery Circuit

CONFIGURATION

4 Configuration Files



WARNING

Only Honeywell trained and authorised persons or qualified persons trained in accordance with the Touchpoint Pro Technical Handbook should edit, restore or delete configurations as errors can adversely affect system functions.

4.1 Viewing and Editing the Configuration

TPPR systems are normally configured to the customer's requirements on manufacture, but you can view and edit the configuration if required.

A configuration timeout is activated when you enter the **System Setup** menu and you will be logged out of configuration if no values are sent to the system for 20 minutes. Any changes that have already been sent to the system will be retained, but any that have been made but not yet sent to the system will be lost. It may be necessary to login and return to **System Setup** and set the module to **Normal State** before retrying the edits.

4.1.1 To View or Edit the Configuration

1. **Log in** as an **Administrator** or **Engineer**.
2. From the **System Status** screen select the **Tool Box** icon then **System Configuration**.
3. Re-enter the password and select **Login**.
4. Select **System Setup**.
5. Select the required module, and then click the **Menu** icon.
6. Select **Edit Configuration** and then follow the on-screen menus.
7. The screen will show the system setup tree listing all installed I/O modules and Control Centre Board(s).
8. Select the + beside each module to expand and show its four channels.
9. Select the required channel, select the **Menu** icon and select **Edit Configuration**.
10. Select the screen that you want to edit (refer to the previous sections).
11. Enter the required **New Value** and select **Send**.
12. The system will show the new values; select **Accept**.
13. Either edit another channel or **Log out**.

You should back up the TPPR system configuration once commissioning is completed, and again after any changes to the setup or software. The TPPR safety system remains operational during this procedure but the controller touch screen, PC Configuration software and Webserver may not be used.

The configuration may be backed up to SD card or USB drive. Backups are stored to a dedicated folder on the SD card or USB drive. Backup files are allocated a sequential number to allow the latest backup to be identified.

The sequence number is determined by examining the files already present in the backup's directory. If more than one storage device is used, the same number may be used on each device. A consistent backup regime should be used to prevent data loss or confusion.

If backing up to SD card, the installed event logging SD card is normally used. This card may be briefly removed to copy the backup file to a PC but the card should be refitted as soon as possible to avoid data loss.

It is possible to back up to a replacement SD card but any events that occur during the backup process will be logged to this SD card and will not be available in the event history when the card is removed.

Note: **Engineer** access level is required to back up the configuration. **Administrator** access level is required to restore configuration.

CONFIGURATION

4.2 To Back Up the Configuration

1. Ensure that the **destination drive** is inserted in the **Control Module**.
2. Login as an **Engineer**.
3. From the System Status screen select the Tool Box icon then System Configuration then System Management.
4. Re-enter the password and select **Login**.
5. Select CCB Management and click on Configuration Backup:
6. Select the required drive.
7. The system will display a message 'The configuration backup process might take a few minutes. The User Interface is not accessible during this time. Do you want to proceed?' Ensure that destination drive is always connected during this operation.
8. Once the action is confirmed, the configuration backup process starts and a progress message is displayed. The backup may take several minutes depending on the system size.
9. The Configuration backup file is stored on the memory device in:

```
TPPR Configuration\TPPR_Config_SystemID_<sequence>.bin
```

```
e.g.: TPPR_Config_SYSTEMSPL0003_009.bin
```

4.3 Restoring the Configuration

Please refer to the *Touchpoint Pro Technical Handbook*.

4.4 Deleting the Configuration

The **Administrator** has the option to delete the system configuration. This option is for specific circumstances only, and is not intended for normal use. See the *Touchpoint Pro Technical Handbook* for further information.

NORMAL OPERATION

5 Normal Day-to-Day Operation

There are several methods of interacting with TPPR:

- Controller Touchscreen (Supplied)
- PC Configuration Software (Licensed Option)
- Webserver (Licensed Option)
- Modbus (Option)

5.1 TPPR Controller Touchscreen Interface

The Touchscreen allows authorised users direct control of all of the TPPR functions. These functions are fully described in the TPPR manual suite.

5.2 TPPR PC Configuration Software Interface

PC Configuration software is an optional remote method for accessing the TPPR via a secure local Network connection.

The PC Configuration tool allows an authorised remote user to configure the controller, and to remotely view or amend the controller configuration.

The PC Configuration Interface is broadly similar to the Touchscreen Interface described in this manual. Please refer to the downloadable PC Configuration User Guide for information on licensing, setup and day-to-day running.

PC Configuration software requires the TPPR controller to be configured with a unique static IP address, which is normally obtained from your site IT department.

Note: You may need **Administrator** privileges on the host PC.

5.3 TPPR Webserver Interface

The Webserver Interface is an optional remote method for accessing the TPPR display and viewing live TPPR events via an Ethernet connection. Events can be acknowledged and reset using the appropriate access passwords and event history can be analysed. Reports can be generated and saved or viewed on the client computer or device.

The Webserver allows an authorised remote user to Accept and Reset events on the controller, and to Inhibit channels, or clear Inhibits.

The Webserver Interface is broadly similar to a limited version of the Touchscreen Interface described in this manual. Please refer to the downloadable Webserver User Guide for information on licensing, setup and day-to-day use.

The TPPR controller requires a static IP address for use with the Webserver, normally obtained from your site IT department.

NORMAL OPERATION

5.4 TPPR Safety Function

During normal Day-to-Day operation:

- The TPPR system will collect data every 250 ms from all of the **Input/Output** modules on the **Ring Network**
- The **Cause and Effect** matrix will be evaluated every 250 ms, and commands sent accordingly to the appropriate output channels. System response time for AIM is ≤ 3 s and ≤ 1 s for DIM
- Any change in status of an I/O channel will be reported to the **User Interface** and logged in the **event history**
- Any occurrence of any of the events listed in the *TPPR Technical Handbook, Ch.11 Error Codes*, will be reported on the User Interface and logged in the event history
- Any system fault or inhibit will cause the **System Fault** relay to open.
- Any failure of the safety function e.g. due to major fault or power loss will cause the **System Failure** relay to open.



WARNING

High 'off-scale' readings may indicate an explosive concentration.

AVERTISSEMENT

Des résultats dépassant considérablement l'échelle peuvent être indicateurs d'une concentration explosive.

5.5 Touchscreen Operation

During normal operation the Touchscreen should show a menu bar at the top and a green tick on the main screen below it. During active events the status changes and an alarm may sound.

Users may touch the screen to show further menus or descriptions (some menus require password access).

A table of icons is given in the *TPPR Technical Handbook, Ch.17 Table of Icons*.

5.5.1 System Status Screen Alert Icons

The **System Status** screen provides a summary of the TPPR status using **Alert Icons** accompanied by the text in bold:





| | | | |
|---|--|---|---|
|  | System OK All input and output channels are Normal |  | Fault One or more channels are in Fault |
|  | Alarm One or more input channels are in Alarm |  | Inhibit One or more channels are in Inhibit |
|  | Warning One or more Warnings are active | | |

Table 8. System Alert Icons

NORMAL OPERATION

5.5.2 Active Event History

The **Active Events** screen lists the current event history in the order that the events occurred, and in colour (Red, Yellow, Orange and Grey) to highlight the severity. TPPR has the option to filter the history into categories, and this is described in *Chapter 6.8 Responding to Alarms, Faults and Warnings*.

5.5.3 Touchscreen Layout

The two main Touchscreen displays are shown in the figure below. The top row shows touch sensitive icons as described in the *TPPR Technical Handbook, Ch.17 Table of Icons*.

Figure 31 may be accompanied by external beacons, sounders and other events depending on your system setup. You can touch each of the alarms, faults or warnings to identify the cause and to acknowledge them as described later.



Figure 30. System Status Normal

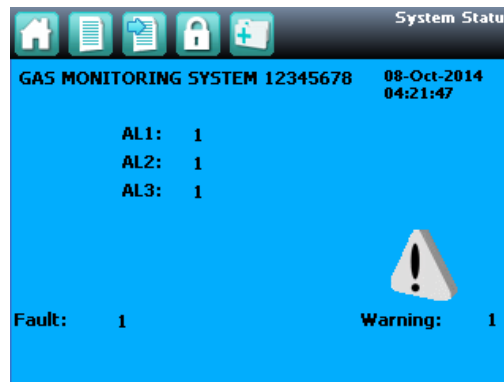
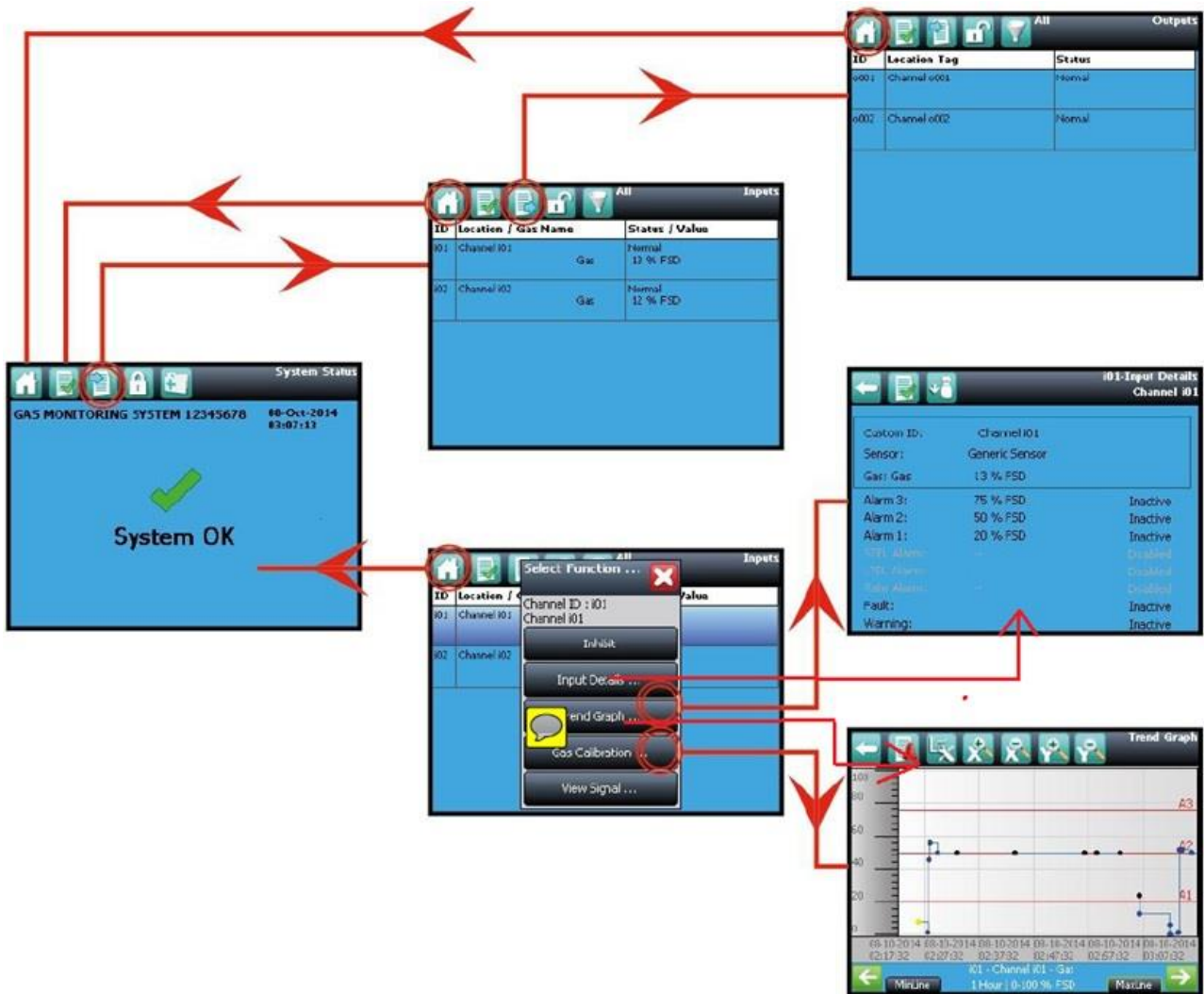

Figure 31. System Status with Example Active Events

NORMAL OPERATION

5.5.4 Touchscreen Navigation

The icons in the navigation bar are used to navigate through the User Interface Software.



Key





| | | | |
|---|----------------------|---|---------|
|  | System Status (Home) |  | Back |
|  | Inputs |  | Outputs |

Figure 32. Touchscreen Navigation – Input and Output

NORMAL OPERATION

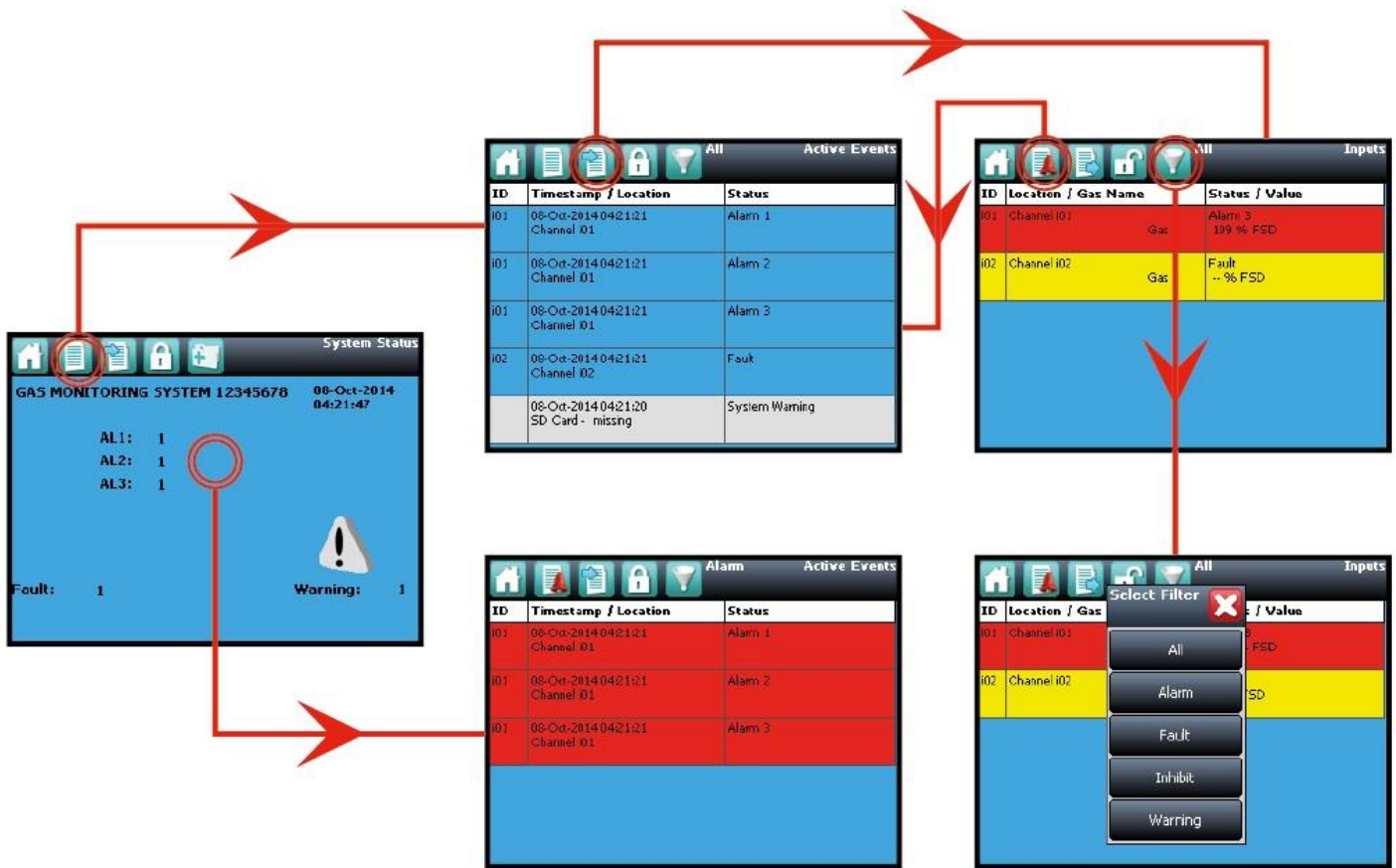

Key

| | | | |
|--|---------------|--|----------------|
| | Active Events | | Login |
| | Filter Events | | User Logged In |
| | Inputs | | Tool Box |

Figure 33. Touchscreen Navigation – Active Events

NORMAL OPERATION

5.5.5 Login Requirements

To login you must be a registered **Administrator**, **Engineer** or **Operator** and have a valid password.

To login, touch the **Login** icon (closed padlock) in the navigation bar and enter the **User Name** and **Password**. The padlock will then change to an open padlock, indicating that a user is logged in.

Note: The user will be automatically logged out after 20 minutes of inactivity or if PC Configuration software assumes remote control. If Touchscreen calibration was in progress you must complete the calibration and log in again before you can proceed with any other actions.

5.6 How to Recalibrate the Touchscreen

Recalibrate the Touchscreen if it does not respond correctly when touched. This process should take less than a minute but can only be performed at the Touchscreen.

Calibration must be fully completed once started as there is no option to abort the process.

To recalibrate the Touchscreen:

1. Login as **Engineer** or Admin
2. Select **Tool Box>Global Settings>Panel Configuration>Calibrate Touch Panel**
3. Follow the instructions, using a finger or soft stylus to touch each panel corner in turn
4. Finally touch the panel centre to exit

Note: The Fault LED may show if calibration is started but not completed, but will stop when calibration is fully completed.

Note: Screen calibration does not time out even when the backlight or UI times out, and user commands will not be available until calibration is fully completed. You must complete the Touchscreen calibration first, and then you can carry on with other activities.

5.7 How to View Input Channels and Input Details

Note: In the Touchscreen view, the **Inputs** and **Outputs** icons toggle – from the **System Status** screen navigation bar only the **Inputs** icon is visible, and when you change to the **Inputs** screen the **Outputs** icon becomes visible.

1. From the **System Status** screen navigation bar, select the **Inputs** icon.
2. A list of all input channels is shown in order of **Channel ID**. The Channel ID, location tag, gas name, status and current reading are shown.
3. The list can be filtered by status – **Alarm, Fault, Inhibit, Warning** or **All**.
4. Select a channel. Choose one of the options described in the table below.

| Option | User Level | Comment |
|---------------|-----------------|---|
| Inhibit | Engineer | Inhibits the channel. On an inhibited channel, this option changes to Clear Inhibit . |
| Calibration | Engineer | Calibrate the channel. |
| Trend Graph | All | Shows the trend graph for the channel. |
| Input Details | All | Shows detailed information about the channel including Custom ID , sensor and gas name, gas reading, configured alarms and alarm levels. |
| View Signal | Administrator | Shows the raw signal being received on the channel. |

Table 9. Input Channel Menu Options

NORMAL OPERATION

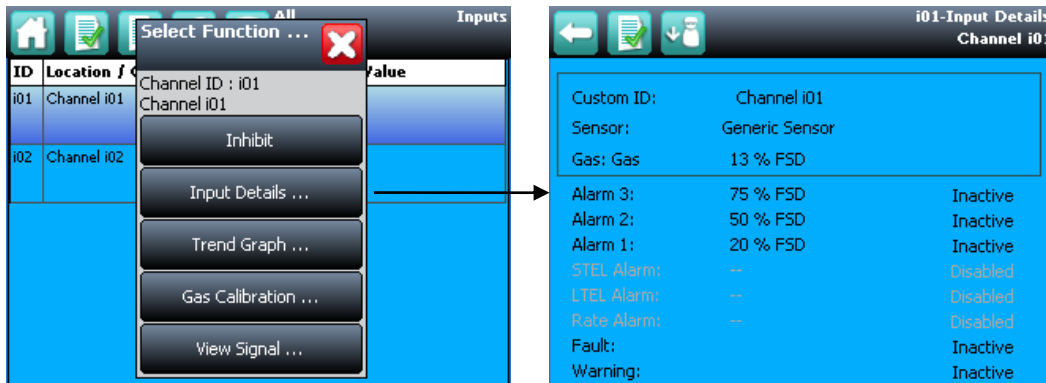

Figure 34. Input Details Screen

5.8 How to View Output Channels

In the Touchscreen view, the **Inputs** and **Outputs** icons toggle – from the **System Status** screen navigation bar only the **Inputs** icon is visible; selecting the **Inputs** icon makes the **Outputs** icon visible.

1. From the **System Status** screen navigation bar, select the **Inputs** icon and then the **Outputs** icon.
2. A list of all output channels is shown in order of Channel ID with its location tag and status as shown below:

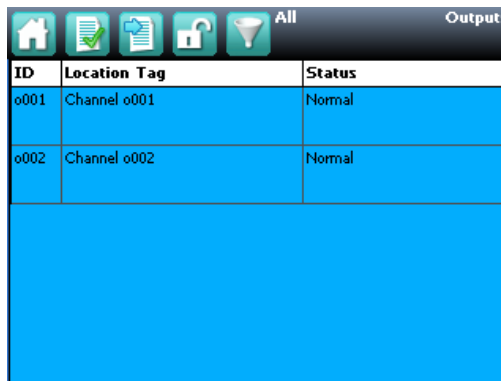

Figure 35. Outputs Screen

3. Select the **Filter** icon to filter by status – **Fault**, **Inhibit**, **Warning** or **All**, as shown below:



Figure 36. Outputs Screen with filter options

4. Select a channel. Depending on your access level, a number of options may be shown:

NORMAL OPERATION

| Function | User Level | Comment |
|------------------|------------|--|
| Inhibit | Engineer | Use this option to Inhibit the channel. Once selected this option changes to Clear Inhibit . |
| Force | Engineer | Use this option to Force a relay output channel to its active state. Once selected this option changes to Clear Force . See <i>Ch. 12.3 and 12.4</i> for more information. The channel status changes to Fault. |
| Force Deactivate | Engineer | Use this option to Force a relay output channel to its deactivated state. Once selected this option changes to Clear Force . See <i>Ch. 12.3 and 12.4</i> for more information. The channel status changes to Fault. |

Table 10. Inhibit / Force Options

5.9 How to View the Trend Graph

The trend graph shows the history of the signal on an analogue input channel. The signal value is logged when it changes, or every one hour if there is no change.

Note: TPPR does not adjust automatically for daylight savings time. Be aware that if the date and time are changed to a time in the past, (for example ending daylight savings time) TPPR will retain a backup of the previous data.

Note: TPPR logs the trend data point when the system is in Field Inputs Test Mode, but does not log it when in the Configuration Settings Test or Cause and Effect Test modes.

Note: The system logs when the value changes, with a resolution determined by the gas range of the channel. For a gas range of less than 10, the resolution is 0.01, for a gas range of 10 to 99 the resolution is 0.1, and for a gas range of 100 or more, the resolution is 1.

Note: The display may not show negative values. If negative values are suspected, due to zero drift or an input fault, use the Trend Graph Settings icon to offset the Y axis zero.

5.9.1 To View the Trend Graph

1. From the **System Status** screen navigation bar, select the **Inputs** icon.
2. A list of all input channels is shown in order of **Channel ID**.
3. Select the required channel, and select **Trend Graph** from the popup menu.
4. The trend graph will be displayed.
5. Use the forward and backward arrows to scroll through the graph. Expand or reduce the axes using the X+, X-, Y+ and Y- buttons.

If there are more data points than the number of pixels available on the screen, TPPR will display the maximum value within each set of points. This is the **MaxLine**. (For example, if one pixel needs to represent 12 seconds, it will display the maximum value that occurred during those 12 seconds.) If you toggle to **MinLine**, TPPR will display the minimum value within each set of points.

Note: Webserver (if used) will by default display both **MaxLine** and **MinLine**. This can be changed to show only **MaxLine**, only **MinLine** or both.

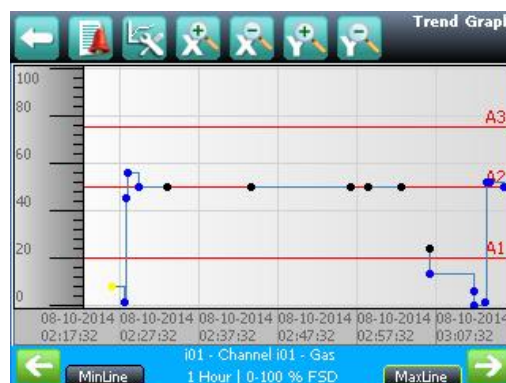

Figure 37. Trend Graph Screen

NORMAL OPERATION

5.10 How to View Event History

The event history for the complete system can be viewed in date order (latest first). The history can be filtered by Alarm, Fault, Inhibit, Warning, All or by selecting a date range.

To access event history, from the **System Status** screen navigation bar select **Tool Box**, then **Event History** or in Webserver directly select the **Event History** icon.

Note: The event history time stamp resolution is ± 5 seconds.

Note: TPPR does not adjust automatically for daylight savings time. Be aware that if the date and time are changed to a time in the past, (for example ending daylight savings time) TPPR will retain a backup of the previous data.

5.11 How to View Event Reports

Several report types can be generated. Reports can be saved to a memory device such as SD or USB, or printed if a printer is connected and configured, but saved reports cannot be viewed until the memory device is opened in a PC.

You can use the UI filters to generate:

- Trending for a specific channel, date range is selectable
- Channel events for a specific channel, date range is selectable
- Configuration for a specific channel
- All events within a selectable date range
- Calibration Report
- System Configuration Report

5.11.1 How to Generate Reports

The report is generated as a Comma Separated Value (.csv) text file.

Depending on the amount of activity, text files can be excessively long and difficult to interpret when printed so it is advisable to import the file into a spreadsheet and use the spreadsheet tools to organise the data.

Webserver (if used) can save or automatically open the report in Microsoft Excel or in a text editor.

Microsoft Excel 2003 is limited to a maximum of 65,526 entries so, if the report is too large, a '*File not loaded completely*' message may be generated. Microsoft Excel 2010 has no such restriction.

To generate a report:

1. From the **System Status** screen navigation bar select **Tool Box**, then **Report**
2. Select the type of report required (see section above), and if applicable select the channel required
3. Select required start and end dates and times
4. Select **Save** or **Print** as required

Note: The Save/Print option is disabled until a channel is selected.

Note: TPPR does not adjust automatically for daylight savings time. Be aware that if the date and time are changed to a time in the past, (for example ending daylight savings time) TPPR will retain a backup of the previous data.

5.11.2 How to Print Active Events

Note: To enable printing, ensure the printer is connected to the Ethernet port and a valid TCP/IP address is being used.

To change print settings:

1. Login as an **Administrator** or **Engineer**
2. From the **System Status** screen select the **Tool Box** icon then **Panel Configuration**
3. Select **Print Active Events**
4. Select **Enabled** or **Disabled** and then **Apply**

When enabled, each event will be sent to the printer as it occurs.

NORMAL OPERATION

5.12 How to Access Diagnostic information

Engineer access level is required.

The **Diagnostics** screen gives information about the firmware versions of system components, and details of the status and any errors. This information could be required by Honeywell Analytics to assist with technical support. The Diagnostics screen also provides access to the TPPR system test modes (see *TPPR Technical Handbook, Ch.16 How to Test the TPPR*).

To access **Diagnostics**, from the **System Status** screen navigation bar select **Tool Box**, then **Diagnostics**. The Diagnostics screen also provides access to a drop-down menu that offers the following tests:

- LED Panel Test
- Field Inputs Test
- Configuration Settings Test
- Cause and Effect Test
- System Relay Test
- Panel Button Test
- LCD Screen Test

Further information can be found in the *Touchpoint Pro Technical Handbook*.

5.13 Managing the Integral SD Card

TPPR is supplied with a 4 GB Industrial Grade FAT32 SD card installed, although you can replace it with a larger card if required. Replacement SD cards should be the same industrial standard to ensure longevity and to protect against data loss.



WARNING

The SD Card is located inside the TPPR Controller's enclosure. Always ensure that the local atmosphere is safe before opening the enclosure..

It is not necessary to 'power off' when removing/inserting an SD Card but **do not touch any exposed terminals or wiring.**

5.13.1 SD Card Purposes

The Controller's SD Card is used for:

- Ongoing storage of event and trend data
- Storage of locally generated reports
- Storage destination for backup files
- Storing configuration backup files
- Internal system management

The SD card should not normally be removed from the controller. However, if it is necessary to remove the card, the controller will continue to cache data but the same card should be reinserted as soon as possible. The cached data will be automatically saved to the card when it is re-inserted.

Under most circumstances the controller can cache several hours of events in internal memory. However, inserting a replacement card causes the cached data to be flushed to this card, and it will no longer be available in the cache for saving to the original card.

NORMAL OPERATION

5.13.2 SD Card Management

The SD card should not normally be removed from the controller. If it is necessary to remove the SD card the controller will continue to cache event and trend data until the SD card is re-inserted.

The following points should be noted:

- The controller will not accept an SD card containing data for another TPPR system.
- Take care to re-insert the correct SD card, or a permanent replacement. The controller will flush cached data to the SD card when a card is re-inserted. If a different SD card is fitted data will become fragmented and may not be useable.
- Similarly, when an SD card has been replaced, the original SD card **should not be re-fitted** for the same reason.
- The TPPR will continue to operate normally with no SD card fitted. The controller can cache several hours of events in internal memory. When the cache is full the oldest data is overwritten and cannot be recovered.
- The TPPR will continue to operate normally with a full SD Card. When the card is full the oldest data will be overwritten. The overwritten event and trend data cannot be recovered.
- The TPPR will warn when the SD card is 80% full, when the card is full, and when previous data is being overwritten

5.13.3 SD Capacity Reporting

The TPPR will warn when the SD card is 80% full and warn again when the card is full, and will warn yet again when previous data is being overwritten.

The TPPR will continue to operate normally with a full SD Card but overwritten event and trend data will be irrecoverable.

5.13.4 How to Check the SD Card Capacity

From the **System Status** screen navigation bar, select **Tool Box>SD Card** to show the card's capacity and unused space.

5.13.5 Ejecting the SD Card

Event and trend data is held in system memory and saved to the SD card several times per minute.

To ensure that chronology is correctly maintained, and to minimise loss of event history data during updates, always use the '**Eject SD Card**' command before removing the SD Card from the TPPR, and subsequently reinsert the same or a permanent replacement card in the system as soon as possible. When the command '**Eject SD Card**' is used, the data currently held in system memory is immediately downloaded to the SD Card.

5.13.6 Replacing an SD Card

Before replacing an SD card, event and trend data should be exported to report files, using the Touchscreen or the Webservice as the source files cannot be read by commercial office software. See the *TPPR Technical Handbook, Ch. 13.12 How to View Event Reports* for further information.

The new card requires no special preparation but should be unlocked and formatted. Prior to installing you may want to use a card reader to copy the TPPR Configuration directory and recent backup files from the old SD card to the new one.

Note: SD Cards must be formatted to **FAT32** only; other file systems are not supported and will not work.

Note: Once an SD card has been replaced the original SD card *should not be reinserted* in the TPPR. This is because some event and trend data will be saved to each card and the data will become fragmented.

5.14 Accessing Help

From the **System Status** screen navigation bar, select **Tool Box**, then **Help**. This help screen will show the date of the last configuration change, configuration version, previous user, about TPPR and the service contact options.

The configuration version increments every time that parameters are written to the TPPR, including during calibration. The configuration version can also be used as a check against unauthorised modification of the system.

- Select About to view software and firmware versions.
- Select Service Contact for details of how to access technical support.

NORMAL OPERATION

5.15 System State Relays

The Control Module has two **System State** relays, rated at 30 VDC, 3 A or 250 VAC, 3 A. The contacts are closed in normal operation and open under the following conditions:

- The **System Fault** relay is open if one or more of the conditions listed Table 11. is present.
- The **System Failure** relay is open if one or more of the conditions listed in Table 11. is present.

The **System State** relays and any other relays configured for safety purposes should be wired to a continuously monitored system for safe operation. This is to ensure that all system faults are detected promptly and appropriate action taken.

Note: During start-up, the **System Failure** relay is open until the CCB is available.

Note: The Redundant CCB taking over from a failed Master CCB is not considered to be a system failure, and the **System Failure** relay will remain in normal state.

| System Failure Relay TB4 | System Fault Relay TB5 |
|--|--|
| Major power loss | Display unit internal fault |
| Fuse blown | Module diagnostics checks reported a fault |
| Controller software diagnostics failure detected | A channel is in inhibit, Fault or Warning state |
| Relay Test is being conducted in Test Mode | Redundant CCB takes over after Master CCB failed |
| | System is in Test Mode, other than LED and LCD Tests |
| | An output is an a Force or Force Deactivate state |

Table 11. System State Relay Operation

5.15.1 ROM Output Relays on System Fail

Note: if there is a system failure all ROM output relays will de-energise, regardless of their configured states.

NORMAL OPERATION

6 Alarms, Faults, Warnings and Inhibits

TPPR may be set up to monitor many types of alarms in different areas of your site or sites. They may also be set up to react in different ways, such as:

- 'Latched' or 'Unlatched' alarms
- Short Term and Long Term Exposure Limits (STEL / LTEL) alarms
- Rate Alarm
- Activation of Relay Outputs
- Voting / Non-voting alarms
- Digital Inputs configured as alarms

6.1 Latching Alarms

During TPPR manufacture of Configuration the alarm channels will have been set as **Latched** or **Unlatched**. The default is usually **Latched**, but this can be changed if required.

Unlatched alarms self-reset once the hazard has cleared, while latched alarms require the user to verify that conditions are safe/normal before manually resetting the alarm.

The STEL alarm can be configured as latching or non-latching. STEL alarms should normally be set to latched to capture the event until it is acknowledged.

The STEL alarm can only be reset when TPPR has calculated that the average gas level over the STEL Time Interval has fallen below the STEL Alarm Level. Therefore, it will take a certain time before the STEL alarm can be reset even though there may no longer be gas present. The length of time before reset is possible depends upon the historic and current gas concentration/time relationship. If set to non-latching, the STEL alarm indication will persist until the average gas level over the STEL Time Interval has fallen below the STEL Alarm Level. See the next section for more detail.

6.2 STEL / LTEL Alarms



CAUTION

In some countries, the use of a STEL alarm with fixed gas detection equipment is not recommended. Refer to local and national regulations for further information.

Short Term Exposure Limits (STEL) and Long Term Exposure Limits are the toxic limits that the human body can tolerate without suffering acute or chronic distress, injury, illness or disease. These figures will vary with every chemical or gas, and they may vary again as more advanced and long-term laboratory testing produces new results.

TPPR uses analogue gas sensors to detect and record ambient toxic gas concentrations for STEL/LTEL. These readings have two functions: firstly a rise in gas concentration above a pre-set STEL base rate will trigger the STEL alarm and secondly a prolonged gas concentration above a pre-set LTEL base rate averaged over a period of time will trigger the LTEL alarm.

TPPR averages STEL gas levels every ½ minute over user-determined rolling periods ranging from 5 to 60 minutes and, for LTEL, continuously rolling periods of 10 minutes fixed at 8-hours total; i.e. 8 hours being the standard shift length.

Full details of STEL/LTEL theory and limitations are given in the *TPPR Technical Handbook, Ch.10 Configuring STEL and LTEL Alarms*. Details on setting it up are given in the *TPPR Technical Handbook, Ch.7 Software Setup and Commissioning*.

6.2.1 Using the STEL Alarm

Use the short term exposure limit (STEL) feature to indicate if a gas sensor is detecting an average level of gas that will result in a hazardous situation.

The STEL feature continuously calculates the average gas level over time using a user selectable time period (STEL Time Interval). An alarm will be indicated if the average gas level exceeds a user selected limit (STEL Alarm Level) within the STEL Time Interval.

STEL alarm functionality is normally associated with personal gas detection equipment where it will give information about an individual's exposure to a hazard. As TPPR and associated sensors are fixed equipment, the user must consider how the STEL feature is to be used as it is the sensor and not an individual that is exposed to gas.

NORMAL OPERATION

The STEL function becomes active and starts monitoring the average gas level when the STEL alarm has been enabled and the input module returns to its normal state. If the STEL alarm had already been enabled prior to TPPR being powered down, then the STEL function becomes active when TPPR is powered up.

6.2.2 Assigning the STEL Alarm to an Output Relay

To assign an output relay to an input channel's STEL alarm, navigate to the cause and effect (C&E) matrix for the required relay and select Alarm 1 (AL1) for the input channel as shown in the figure below.

Threshold Alarm 1 and STEL share the output relay. If the channel is programmed for threshold levels then AL1 selection is used for the first threshold alarm and STEL may not be assigned to a relay. Similarly, if the channel is programmed for STEL, AL1 is reserved for STEL and may not be assigned to a threshold alarm.

This relay will also be assigned to the required inputs for Threshold alarm 1.

| ID/Location | AL1 | AL2 | AL3 | FLT | INH | WRN |
|----------------|-------------------------------------|--------------------------|--------------------------|--------------------------|--------------------------|--------------------------|
| Select All | <input type="checkbox"/> | <input type="checkbox"/> | <input type="checkbox"/> | <input type="checkbox"/> | <input type="checkbox"/> | <input type="checkbox"/> |
| 133 – 1 mA Ch1 | <input checked="" type="checkbox"/> | <input type="checkbox"/> | <input type="checkbox"/> | <input type="checkbox"/> | <input type="checkbox"/> | <input type="checkbox"/> |

Select AL1 to assign this relay to the selected inputs STEL alarm. Note that this relay will also be assigned to the selected inputs alarm 1 threshold.

6.3 Rate Alarm

Rate Alarms can be setup to trigger when a gas concentration changes quickly. An alarm may be triggered by a rising or falling gas level even though the gas has not reached a threshold level. The extent of change and the time period are programmable.

6.4 Relay Activated Outputs

TPPR has the ability to automatically operate relay controlled outputs when an alarm is triggered. These outputs are determined during commissioning and may be used to control any or all of these:

- Light Stacks and Sirens
- Automated Emergency Services alerts
- Actuator controlled vents, valves and switches (i.e. power-breaking, purging, sprinkling or flooding)
- Exit door release
- Entry Barrier closing

6.5 Sensor Over Range Operation

TPPR can display a warning if an input signal exceeds the configured gas range. Two signals are provided:

- Full Scale Exceeded
- Over Range Warning

The Full Scale Exceeded warning is displayed, if enabled, when the gas reading exceeds the programmed range. The warning is cleared automatically when the signal returns below 100% of the selected range.

The Over Range Warning is programmable. If enabled, the warning is displayed when the gas reading exceeds the programmed level (default is 110% of the programmed range).



WARNING

The **Over Range Warning** must be configured to Latching to ensure compliance with EN60079-29-1.

NORMAL OPERATION

The Over Range Warning has a higher priority than the Full Scale Exceeded warning. If the Over Range Warning is asserted, the Full Scale Exceeded warning is cleared.

6.5.1 Gas Readings

The maximum gas readings experienced may be seen by viewing the Trend graph.

6.6 Catalytic Sensor Over Range Operation

The reading from a catalytic sensor can return to a false low if the gas level exceeds the sensor operating range. The latched Over Range Warning indicates that an exceptionally high gas level has been detected and further investigation is required.

The Over Range Warning requires an extra Reset operation to clear. The first Reset clears the over range warning, the second reset clears any other conditions, provided that gas readings have returned to suitably low levels.

The Over Range Warning is available on mV channels (default: enabled) and on mA channels (default: disabled) for use with catalytic sensors connected via a mA transmitter.

6.7 Full Scale Exceeded and Over Range Warning Operation

The following two examples show the detailed operation of the **Full Scale Exceeded** and **Over Range Warning** warnings.

Note: For clarity alarms (AL1, AL2, AL3) and other conditions are not shown.

Pre-conditions:

- **Full Scale Exceeded** is enabled and set to **100%** of the pre-set gas range
- **Over Range Warning** is enabled and set to **120%** of the pre-set gas range (Latched)



WARNING

The **Over Range Warning** parameter must be configured to **100 %FSD** to ensure compliance with *EN60079-29-1*.

NORMAL OPERATION

6.7.1 Event Status with a Rising Gas Reading

| Rising Gas Reading | Event Status (Full scale/Over Range) | Event History (Sequential Entries) | Remarks |
|--------------------|--------------------------------------|--|--|
| Below 100% | — | — | — |
| ≥100% & <120% | Full Scale Exceeded Active | Full Scale Exceeded Active | — |
| ≥120% | Over Range Warning Active | Full Scale Exceeded Active Full Scale Exceeded Cleared Over Range Active | Full Scale Exceeded auto-cleared (overwritten by Over Range Warning) |

Table 12. Rising Gas Reading

6.7.2 Event Status as the Gas Concentration Decreases

The indicated value remains at the programmed Over Range Warning value. A "greater than" symbol (>) is displayed to indicate that the programmed level has been exceeded. The latched reading may be reset once the gas concentration has decreased below the programmed level.

The **Over Range Warning** remains **Latched**.



WARNING

A potentially explosive gas concentration may still exist at this point.

Note: In the following example, **Full Scale Exceeded** will not reappear until the gas concentration falls to between 100% & 120% of the pre-set gas range and the latched **Over Range Warning** has been reset manually.

| Falling Gas Concentration | Event Status (Full Scale/Over Range) | Event History (Sequential Entries) | Remarks |
|---------------------------|---|---|--|
| ≥100% & <120% | Over Range Warning still Active (latched) | Full Scale Exceeded Active Full Scale Exceeded Cleared Over Range Active | Full Scale Exceeded is hidden while Over Range Warning is active. |
| ≥100% & <120% | Full Scale Exceeded | Full Scale Exceeded Active Full Scale Exceeded Cleared Over Range Active Over Range Cleared Full Scale Exceeded Active | 1 st manual reset attempted by user. Over Range Warning reset was successfully. Full Scale Exceeded may appear. |
| Below 100% | — | Full Scale Exceeded Active Full Scale Exceeded Cleared Over Range Active Over Range Cleared Full Scale Exceeded Active Full Scale Exceeded cleared | The 2 nd manual reset can be applied now and Full Scale Exceeded should auto-clear. |

Table 13. Falling Gas Reading

NORMAL OPERATION

6.7.3 Special Considerations when using Catalytic Sensors

Touchpoint Pro continually carries out diagnostics to prove that the system is operating correctly and faults such as wiring faults will clear automatically when the system detects that the fault has been corrected.

In rare circumstances (due to insufficient oxygen for the sensor to operate correctly) a high gas concentration could occur while the system is in fault, and which may not be detected by the system due to the fault. It is therefore *highly recommended* to configure at least one Relay Output to **latch on fault** on channels that are used with catalytic sensors.

6.7.4 Configuration of Relay Outputs

Each output must be configured as Normally Energized, Alarm Update Enable not selected, and Latch Function selected, as shown in the following example:

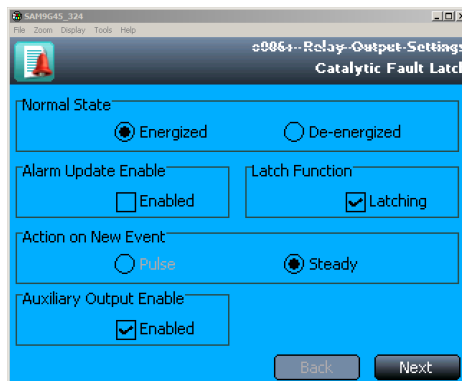

Figure 38. Fault Latch Output Configuration

Auxiliary Output **Enable** should normally be selected if any load is connected to the module auxiliary output supplies (e.g. a sounder or a beacon). A fault will then be generated if the output current limit is exceeded.

Each output must be configured as Output Type **Normal**, with a cause and effect matrix similar to the following example. The cause and effect matrix must include all channels using catalytic sensors, in this instance three mV channels.

| ID/Location | AL1 | AL2 | AL3 | FLT | INH | WRN |
|--|--------------------------|---|--------------------------|-------------------------------------|--------------------------|--------------------------|
| Select All | <input type="checkbox"/> | <input type="checkbox"/> | <input type="checkbox"/> | <input type="checkbox"/> | <input type="checkbox"/> | <input type="checkbox"/> |
| mV Channel 1 | <input type="checkbox"/> | <input type="checkbox"/> | <input type="checkbox"/> | <input checked="" type="checkbox"/> | <input type="checkbox"/> | <input type="checkbox"/> |
| mV Channel 2 | <input type="checkbox"/> | <input type="checkbox"/> | <input type="checkbox"/> | <input checked="" type="checkbox"/> | <input type="checkbox"/> | <input type="checkbox"/> |
| mV Channel 3 | <input type="checkbox"/> | <input type="checkbox"/> | <input type="checkbox"/> | <input checked="" type="checkbox"/> | <input type="checkbox"/> | <input type="checkbox"/> |
| At least One Alarm <input type="checkbox"/> Enabled | | Vote Count 1 Channels Selected: 3 | | | | |

To allow zoning of sensors it is possible to assign as many or as few input channels to the relay output channels as required, however it is a requirement of the *European Performance Approval* that **at least one channel is configured to latch** such a fault.

NORMAL OPERATION

6.8 Responding to Alarms, Faults and Warnings

Users may respond to alarms and other events by various methods.

All users may view events, as described below.

Events may be acknowledged or reset by various methods, including the controller front panel **Accept** and **Reset** buttons, touch screen menus, remote DIM-controlled switches, and, if enabled, Webserver and Modbus.

Access to controller **Accept** and **Reset** functions may be restricted to logged in users. The system may be configured so that the **Accept** and **Reset** buttons are password protected and require a user to login. Refer to the *TPPR Technical Handbook* for further information.

Note: Switches and buttons connected to DIM channels may be used to provide remote **Accept**, **Reset** and **Inhibit** functions. These inputs cannot be password controlled so it is the user's responsibility to limit access, if required, by using other methods such as key operated switches. Refer to the *TPPR Technical Handbook* for further information.

Note: Alarms may be commissioned as '**Latched**' or '**Unlatched**'. Unlatched alarms self-reset once the hazard has cleared, while latched alarms require the user to verify that conditions are safe/normal before manually resetting the alarm.



WARNING

High 'off-scale' readings may indicate an explosive concentration.

AVERTISSEMENT

Des résultats dépassant considérablement l'échelle peuvent être indicateurs d'une concentration explosive.



WARNING

Over range gas alarms should be investigated before attempts are made to reset them.

NORMAL OPERATION

6.8.1 To View Active Alarms

Active alarms can be viewed in three ways:

- From the **System Status (Home)** screen, select the flashing red bell **Alarm** icon.
- From the **System Status (Home)** screen navigation bar, select the **Active Events** icon, then the **Filter** icon and then select **Alarm** from the popup menu.
- From the **System Status** screen navigation bar, select the **Inputs** icon, then the **Filter** icon and select **Alarm** from the popup menu.

The screen will display a list of all the input channels that have active alarms, starting with the most recent event. Unacknowledged alarms will flash, acknowledged ones will not flash.

Note: The display shows the channel ID, location tag and the time of the alarm. All alarm levels will be shown if more than one alarm level has been triggered on the same channel.

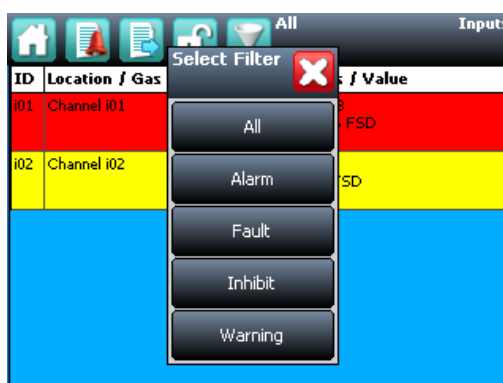

Figure 39. Active Events Screen with Filter Options

6.8.2 To Acknowledge an Active Alarm

An active alarm can be acknowledged from the controller in three ways:

- Select the **Accept** button on the front panel of the TPPR Controller for >0.5 s. This will acknowledge **all active events, including faults and warnings**.
- From the **Inputs** screen, select the channel and select **Acknowledge** from the popup menu. This will acknowledge **all active events for that channel only**.
- From the **Active Events** screen, select the alarm and select **Acknowledge** from the popup menu. This will acknowledge **only the selected alarm**.

Acknowledging an alarm silences the buzzer and the alarm icon stops flashing, but latched alarms are not automatically reset.

Note: The Alarm Update function modifies the operation of Output channels when events are acknowledged. Refer to the *TPPR Technical Handbook*.

NORMAL OPERATION

6.8.3 To Reset a Latched Alarm

Alarms may only be reset if the event causing the alarm has been cleared; typically when the reported gas level has fallen below the alarm threshold.

If the **Over Range Warning** signal is latched, two **Reset** operations are required. The **first Reset** clears the Over Range Warning, the **second Reset** clears any other conditions.

CAUTION

The TPPR system is designed to alert the user to potentially dangerous events and to trigger protective measures. It is the User's responsibility to ensure that the site emergency response procedures are initiated before accepting alarms, and that the danger has been investigated and cleared before resetting the alarms.

Alarms cannot be reset until the gas concentration is below the threshold limits.

An **STEL Alarm** cannot be reset if the current value of the time weighted average (TWA) is above the pre-set alarm threshold.

An **LTEL Alarm** cannot be reset if the current gas reading is above the pre-set alarm threshold.

A latched alarm can be reset in three ways:

1. Select the **Reset** button on the front panel of the TPPR for >0.5 s. This will reset ALL latched alarms, faults and warnings, provided that the event has cleared. It will also reset any latched relay outputs.
2. From the **Inputs** screen, select the channel and select **Reset** from the popup menu. This will reset all latched events for the channel, provided that the input signal has returned to below the alarm threshold status.
3. From the **Active Events** screen, select the alarm and select **Reset** from the popup menu. This will reset only the selected alarm.

6.9 Viewing Faults and Warnings

The **Active Events** screen lists the current event history in the order that the events occurred. TPPR has the option to filter the history into categories, as shown in the descriptions and picture below.

Events are colour-coded for easier recognition; **Red** Alarm, **Yellow** Fault, **Orange** Inhibit, **Grey** Warning.

Faults and warnings may only be reset if the reported event has been cleared, for instance the fault has been rectified.

6.9.1 To View Faults and Warnings

Detailed information about active **Faults and Warnings** can be viewed in two ways:

From the **System Status** screen, select either the **Fault** yellow triangle icon, or the **Warning** grey triangle icon. The screen will show a filtered list of only the active Faults or Warnings.

Select the **Active Events** icon to show all active events, then the **Filter** icon and select **Fault** or **Warning** from the popup menu.

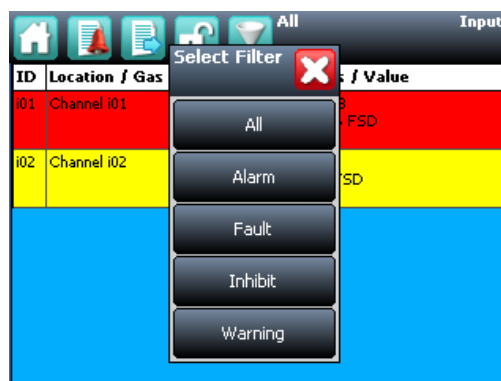

Figure 40. Active Events Screen Showing the Filter Option Buttons

NORMAL OPERATION

6.9.2 To Acknowledge (Accept) a Fault or Warning

Operator or higher access level may be required.

An active fault or warning can be acknowledged in three ways:

Select the **Accept** button on the front panel. This will acknowledge **ALL active events**.

From the **Inputs** or **Outputs** screen select the individual channel and select **Acknowledge** from the popup menu. This will acknowledge all active events for the channel.

From the **Active Events** screen, select the fault or warning and select **Acknowledge** from the popup menu. This will acknowledge only the selected fault or warning.

The channel, LED and icon will stop flashing when a fault or warning is acknowledged.

Note: The **Accept** button must be pressed for **at least 0.5 seconds**.

6.9.3 To Reset a Latched Fault or Warning

Operator or higher access level may be required.

A latched fault or warning can be reset in three ways:

- Press the **Reset** button on the front panel. This will reset **ALL latched alarms**, faults and warnings, provided that the event has cleared. It will also reset any latched relay outputs.
- From the **Inputs** or **Outputs** screen, select the channel and select **Reset** from the popup menu. This will reset all latched events for the channel, provided that the input signal has returned to Normal status.
- From the **Active Events** screen, select the fault or warning and select **Reset** from the popup menu. This will reset only the selected fault or warning.

Note: The **Reset** button must be pressed for **at least 0.5 seconds**.

6.10 Inhibiting a Channel

Engineer or **Administrator** access level is required.

If a channel is in Alarm, inhibiting the input will clear the alarm status for that channel. Inhibiting an output associated with that channel will deactivate that output, but the input will remain in alarm state. The alarm will continue to be reported on the controller and may affect other outputs in the cause and effect matrix.

Note: Channels may be inhibited automatically by the TPPR. See next page for more information.

6.10.1 How to Inhibit a Channel

Both input and output channels can be inhibited.

1. From the **System Status** screen navigation bar, select the **Inputs** icon and, if appropriate, the **Outputs** icon.
2. Select the required channel and select **Inhibit** from the popup menu.
3. To clear inhibits, select the required channel and select **Clear Inhibit** from the popup menu.

NORMAL OPERATION

6.10.2 Channel Auto-Inhibits

Auto-inhibits may occur when a mV input channel has been configured but not yet calibrated, when a transmitter is signalling Inhibit, or when an **Inhibit delay** time is running. Please refer to the *TPPR Technical Handbook, Ch. 17 System Troubleshooting* for further information.

Auto-inhibits cannot be cleared manually.



CAUTION

It is possible to have more than one inhibit condition active on a channel, and you have to resolve all inhibit conditions before the inhibit can be cleared.



Figure 41. Inputs Screen with menu options

MAINTENANCE

7 Maintenance Procedures



WARNING

Maintenance procedures should only be carried out by Honeywell authorised persons or qualified persons trained in accordance with the *Touchpoint Pro Technical Handbook* as errors can adversely affect system functions.

This chapter describes how to perform common maintenance operations.

The required frequency of inspection and maintenance will depend on local site conditions and will need to be established through experience. Please refer to the following standards or other local or national regulations for guidance on establishing an appropriate maintenance routine:

EN 45544-4 contains information on the use and maintenance of electrical apparatus used for the direct detection and direct concentration measurement of *toxic gases and vapours*.

Note: When finished, ensure that all enclosures are closed and locked, and ensure that the maintenance and rectification is recorded.



WARNING

If the relays are switching mains voltages, hazardous live terminals may be present within the Relay Output Module even if the Touchpoint Pro system is isolated.

7.1 Routine Maintenance



WARNING

To avoid any unwanted activation of output devices (e.g. emergency flooding) always inhibit or disable relay activated outputs before exercising the relays and remember to enable them when testing is finished.



CAUTION

Do not use solvents or abrasives to clean any part of the TPPR as this may cause irreparable damage.

Routinely (i.e. daily, weekly or monthly depending on local conditions) carry out the following tasks:

- Clean the Touchscreen with a soft cloth and mild detergent, or use a proprietary VDU screen cleaner.
- Check the screen for correct operation
- Remove dust and other contamination (particularly on rack mounted units or enclosure vents).
- Periodically exercise the relays to confirm functionality (see the *TPPR Technical Handbook, Ch.16 How to Test the TPPR System*).
- Check that the SD Card still has free space.
- Check the condition of the enclosure for security, corrosion, deterioration of door seals, blocked ventilation, loose fixings and other damage that could impair the safety and operation of the equipment or its safety function.

MAINTENANCE

7.2 Periodic Maintenance

Periodic inspection and cleaning should be carried out weekly, monthly or 6-monthly as necessary.

Refer also to the recommended periodic system tests described in *Chapter 8 How to Test the TPPR System*.

7.2.1 Battery Enclosure Maintenance

Open the battery enclosure (if fitted) and:

- Visually inspect the Touchpoint Pro Battery Box, batteries and all exposed cabling, particularly for signs of corrosion.
- Check the batteries for physical security, cable damage, or loose connections.
- Check that the enclosure vents have not become obstructed. Remove debris with a vacuum cleaner nozzle, taking care not to disturb wiring or short the terminals.

Close and secure the door when finished.



CAUTION

The sealed batteries contain lead and acid. Treat all damaged batteries and leaks as hazardous spills, and dispose of the battery and contents as hazardous waste.

7.2.2 Cable Maintenance

Additionally, especially following ground maintenance or severe weather:

- Visually inspect all cabling and trunking, checking for signs of damage, perishing or loose connections.

MAINTENANCE

8 How to Test the TPPR System

8.1 Introduction

The TPPR system has the following test modes, which together enable a comprehensive test of the system:

1. **LED Panel Test** – tests that all of the panel LEDs are working.
2. **Field Inputs Test** – tests all input channel devices without affecting any outputs. Gas test, force mA, confirmation of correct device connection etc.
3. **Configuration Settings Test** – forces the TPPR input channels to specific levels and shows the corresponding states, threshold alarm levels, over-range, warning/fault etc.
4. **Cause and Effect Test** (carried out from the output channel menu) – forces the TPPR input channels to specific states to test that the correct output channels are activated.
5. **Panel Button Test** – tests that the panel buttons are working
6. **System Relay Test** – tests that the **System Failure** relay and **System Fault** relays are working
7. **LCD Screen Test** – provides a visual check of the LCD screen

Note: It is recommended that the audio / visual functionality of the system (test modes 1, 5 and 7) are tested annually. Test modes 2, 3 and 4 should be run as a part of commissioning or after any modification to the system which changes the system setup.

It is recommended that the system relays (test mode 6) and the Relay Output Module (Force) relays are tested at least every five years.



WARNING

While in test mode, the TPPR is not operational as a safety system and any field device inputs may be ignored. The **System Fault** relay may open and the **System Failure** relay will remain in the current state. Always put alternative safety arrangements in place before carrying out these tests.



WARNING

During the **Cause and Effect Test**, outputs will be generated and relays will be activated. To avoid any unwanted activation of output devices (e.g. emergency flooding) always inhibit or disable relay activated outputs before starting and enable them when testing is finished.

When a test mode is active the **System Fault** relay will normally open and a **Test Mode Fault** will be shown as an **Active Event** on the User Interface, which cannot be reset. The exceptions are the LED Panel Test and LCD screen, which do not indicate a fault.

Once a test mode is active, the system will remain in test mode until the test is exited. The only exception is in the case of a power cycle of the TPPR, when it will restart in normal mode.

Note: After 20 minutes of inactivity the system will logout and return to the **System Status** screen. However it is still running in test mode and you will need to login to complete the tests.

The optional **PC Configuration Software cannot be used** while a test mode is active.

All events generated while the system is in test mode will be logged in the event history. Therefore a test record can be generated once testing is completed (see the *TPPR Technical Handbook, Ch. 7.6 How to Print Active Events*).



MAINTENANCE

8.2 LED Panel Test

Engineer access level is required.

The purpose of this test is to check that the LEDs on the panel are working correctly. This test does not indicate a Fault while in progress.

How to use the LED Panel Test mode:

8. Login as an **Engineer**.
9. From the **System Status** screen select the **Tool Box** icon: 
10. Select Diagnostics.
11. Select the **Menu** icon: 
12. Select **LED Panel Test**.
13. The system will ask you to confirm, select **OK** to proceed.
14. The system will illuminate all LEDs and then cycle through the LEDs turning each one on in turn.
Note: The green power LED will remain illuminated throughout if it is working correctly.
15. At the end of the test the system will ask you to confirm the LED test passed.



8.3 Field Inputs Test

Engineer access level is required.



During this test, all field device inputs will be displayed, but the **Cause and Effect** matrix will not be evaluated. No outputs will be generated.

The purpose of this test is to check that the input field devices are connected to the correct input channel. Typically, this can be done either by applying a test gas to the sensor in the field or by forcing the mA output of the sensor to a given value. The gas concentration and alarm states raised for the channel can then be viewed on the Touchscreen UI or PC GUI. The system fault relay will be open.

How to use the Field Inputs Test mode:

1. Login as an **Engineer**.
2. From the **System Status** screen select the **Tool Box** icon: 
3. Select Diagnostics.
4. Select the **Menu** icon: 
5. Select Field Inputs Test.
6. The system will ask you to confirm, select **Yes** to proceed.
7. The system will display a confirmation message, click on OK and you will be automatically navigated to the Active Events screen.
8. Proceed with the test of the field devices. To see more detailed information at any time, select the channel of interest and select Input Details from the popup menu.

Note: If the test is done from the **Active Events** screen, the channel of interest will be shown as soon as its state changes, i.e. a threshold alarm is generated. Alternatively, you may wish to work from the Inputs screen (return to System Status screen and select Inputs) by scrolling down to the channel you want.

9. When the test is complete, return to the **System Status** screen and select the **Tool Box** icon: 
10. Select Diagnostics.
11. Select the **Menu** icon: 
12. Select Stop Field Inputs Test.
13. The system will show a confirmation message that it has returned to normal operation.



WARNING

Check and ensure that the system is restored to normal operation once all testing is finished.

MAINTENANCE







8.4 Configuration Settings Test

Engineer access level is required.

During this test, all field device inputs will be ignored by the TPPR. The **Cause and Effect** matrix will not be evaluated. No outputs will be generated.

The purpose of this test is to check that input channels are configured correctly, including alarm, warning, fault thresholds etc. The gas concentration and alarm states raised by forcing the input value can be viewed on the TPPR UI or the PC GUI. The system fault relay will be open.

8.4.1 How to use the Configuration Settings Test Mode

1. Login as an **Engineer**.
2. From the **System Status** screen select the **Tool Box** icon: 
3. Select Diagnostics.
4. Select the **Menu** icon: 
5. Select Configuration Settings Test.
6. The system will ask you to confirm; select **Yes** to proceed.
7. The system will display a confirmation message, click on **OK** and you will be automatically navigated to the **Inputs** screen.
8. Select the channel to be tested and select **Input Details** from the popup menu.
9. From the **Input Details** screen, select the **Menu** icon: 
10. Select Force Value.
11. Enter the gas concentration that you want to simulate. This can include over and under range values.
12. The system will return to the **Input Details** screen, where it will show the simulated gas value as well as any corresponding active events (e.g. Alarm 1).
13. When ready, select the **Menu** icon: 
14. Select Clear Force.
15. Repeat steps 9 – 14 as required, completing the channel tests.
16. Return to the **Inputs** screen and repeat steps 8 – 14 for the next channel.
17. When the test is complete, go to the **System Status** screen and select the **Tool Box** icon: 
18. Select Diagnostics.
19. Select the **Menu** icon: 
20. Select Stop Configuration Settings Test.
21. The system will show a confirmation message that it has returned to normal operation.



WARNING

Check and ensure that the system is restored to normal operation once all testing is finished.

MAINTENANCE

8.5 Cause and Effect Test

Engineer access level is required.

During this test, all field device inputs will be ignored by the TPPR system. The **Cause and Effect** matrix will be evaluated based on simulated input states and outputs will be generated. The system fault relay will be open.







WARNING

During the Cause and Effect Test, **outputs will be generated and relays will be activated**. To avoid any unwanted activation of output devices (e.g. emergency flooding) always inhibit or disable relay activated outputs before starting and remember to enable them when testing is finished.

This test has two purposes:

1. To verify that Cause and Effect matrix configuration is correct by forcing the state of the input channels to various combinations. The activated/de-activated output channels corresponding to the forced state of input channels can be viewed on the TPPR UI or Webserver (if enabled).
2. To check that the output channels are configured correctly, including delay on/off times etc. By forcing the state of the output channel to change the corresponding change in the output device state can be viewed on the TPPR UI or Webserver (if enabled).

8.5.1 How to use the Cause and Effect Test Mode:

1. Login as an **Engineer**.
2. From the **System Status** screen select the **Tool Box** icon: 
3. Select **Diagnostics**.
4. Select the **Menu** icon: 
5. Select **Cause and Effect Test**.
6. The system will ask you to confirm, select **Yes** to proceed.
7. The system will display a confirmation message, click on **OK** and you will be automatically navigated to the **Outputs** screen.
8. Select the channel to be tested and select **Output Details** from the popup menu.
9. Select the **Menu** icon: 
10. Select **Force Input States** to do a full test of the **Cause and Effect** matrix (test purpose 1 described above).
11. The system will display a matrix of all the input channels that are linked to the output channel being tested.
12. Select the input channel states that you want to simulate, and click on **Force**. The cells corresponding to the forced states will be coloured.
13. The system will return to the **Outputs** screen where the results of the forced input states can be viewed.
14. When ready, return to the **Output Details** screen and select the **Menu** icon: 
15. Select **Clear Force**.
16. Repeat steps 8 – 15 for the next channel.
17. To force the output relays (test purpose 2, described above) select the channel to be tested and select **Output Details** from the popup menu.
18. Select the **Menu** icon and select **Force** from the popup menu. The output will now be activated and the result can be verified.
19. When ready, select the channel again, and select **Clear Force**.
20. Repeat steps 17 – 19 for the next channel.
21. When the test is complete, go to the **System Status** screen and select the **Tool Box** icon then **Diagnostics**.
22. Select the **Menu** icon: 
23. Select **Stop Cause and Effect Test**.
24. The system will show a confirmation message that it has returned to normal operation.



WARNING

Check and ensure that the system is restored to normal operation once all testing is finished.



MAINTENANCE

8.6 Panel Button Test

Engineer access level is required.

The purpose of this test is to check that the buttons on the panel are working correctly.

How to use the Panel Button Test mode:

1. Login as an **Engineer**.
2. From the **System Status** screen select the **Tool Box** icon: 
3. Select Diagnostics.
4. Select the **Menu** icon: 
5. Select **Panel Button Test**.
6. The system will ask you to confirm, select **Yes** to proceed.
7. The system will confirm you are in panel button test mode. Press **OK** to proceed.
8. Follow the on-screen prompts to test the panel buttons
9. At the end of the test the system will display the test results
10. Press **OK**.
11. Select the **Menu** icon: 
12. Select Stop panel Button Test.
13. The system will show a confirmation message that it has returned to normal operation.



8.7 System Relay Test

Engineer access level is required.

The purpose of this test is to check that the System Failure and System Fault relays are working correctly.

Note: It may be necessary to disconnect wiring to higher level systems from TB4 (System Failure) and TB5 (System Fault) on the TPPR controller. This test may cause higher level systems to activate if connected.

How to use the System Relay Test mode:

1. Login as an **Engineer**.
2. From the **System Status** screen select the **Tool Box** icon: 
3. Select Diagnostics.
4. Select the **Menu** icon: 
5. Select **System Relay Test**.
6. The system will ask you to confirm, select **Yes** to proceed.
7. The system will confirm you are in relay test mode. Press **OK** to proceed.
8. The system will operate the System Fail relay and ask the user to confirm the monitoring applied by the engineer has indicated that the relay has been activated (contacts closed).
9. The system will operate the System Fail relay and ask the user to confirm the monitoring applied by the engineer has indicated that the relay has been deactivated (contacts permanently open with no state switching).
Note: The System Fail relay will be toggling during this test to ensure that no contacts have welded
10. The system will operate the System Fault relay and ask the user to confirm the monitoring applied by the engineer has indicated that the relay has been activated (contacts closed).
11. The system will operate the System Fault relay and ask the user to confirm the monitoring applied by the engineer has indicated that the relay has been deactivated (contacts permanently open with no state switching).
Note: The System Fault relay will be toggling during this test to ensure that no contacts have welded.
12. At the end of the test the system will display the test results.
13. Press **OK**.
14. Select the **Menu** icon: 
15. Select Stop System Relay Test.
16. The system will show a confirmation message that it has returned to normal operation.
17. Reconnect TB4 and TB5 if necessary.



MAINTENANCE

8.8 LCD Screen Test

Engineer access level is required.

The purpose of this test is to check that the LCD screen is working correctly. This test does not indicate a Fault while in progress.

How to use the LCD Screen Test mode:

1. Login as an **Engineer**.
2. From the **System Status** screen select the **Tool Box** icon: 
3. Select **Diagnostics**.
4. Select the **Menu** icon: 
5. Select **LCD Screen Test**.
6. The system will display a series coloured bars and a progress bar.
7. When the progress bar completes the system asks you to confirm the bars were visible
8. Then select **Yes** if the bars were visible and **No** if the screen appears abnormal.



8.9 How to Exercise the Output Relays



WARNING

To avoid any unwanted activation of output devices (e.g. emergency flooding) always inhibit or disable relay activated outputs before exercising the relays and remember to enable them when testing is finished.

To test the Relay output channels by forcing the relays to a specific state:

1. Login as an **Engineer**. Navigate to the Outputs screen:
 - a) From the **System Status** screen select the **Inputs** icon: 
 - b) Toggle the Inputs Icon to select the **Outputs** icon: 
2. Select the channel to be tested, and then select **Force** or **Force Deactivate**, as required. The channel will indicate a Fault until the action is cancelled.
3. When ready, select the channel again, and select **Clear Force** from the popup menu.
4. Repeat steps 4 and 5 for all relay output channels.

Note: The system will indicate a fault and the System Fault relay will open while a Force condition is present.



WARNING

Check and ensure that the system is restored to normal operation once all testing is finished.

MAINTENANCE

9 Calibrating Gas Sensors

This section is included for information only. Please refer to the *Touchpoint Pro Technical Handbook* for detailed instructions.



WARNING

Only Honeywell trained and authorised persons or qualified persons trained in accordance with the *Touchpoint Pro Technical Handbook* should carry out Calibration procedures as errors can adversely affect system functions.

All gas sensors must be calibrated on commissioning, on replacement, at regular intervals specified in their user manuals, or when dictated by usage. (Touchpoint Pro can be programmed to generate periodic calibration reminders. See the *TPPR Technical Handbook* for details.)

Note: Calibration data is not retained following a restore operation and calibration reminders may require updating following recalibration.

The basic calibration procedure is to first clear the sensor of any target gas and then introduce a known concentration of a test gas followed by a rest period to ensure that the sensor goes back to normal.



CAUTION

Ensure that executive actions/outputs are inhibited and alternative safety arrangements are made before starting any TPPR testing or calibration.



CAUTION

It is expected that mA sensors will be calibrated at the sensor or field device. The TPPR mA calibration is not intended to calibrate the sensor, but to align the TPPR 4-20mA current loop with the sensor current loop zero and span settings.

The TPPR mA calibration should not be used to calibrate the sensor zero and span, or to compensate for deficiencies in the sensor or transmitter calibration. Failure to observe this can result in significant accuracy errors.

9.1.1 Calibration Definitions

- **Clean Air** describes ambient air that has a nominal zero concentration of the target gas being sensed.
- **First Span** is the name given to the first gas span reading of a new mV sensor, which is used to monitor the sensor's sensitivity over time.
- **An Over Range Warning** occurs when a mV sensor exceeds 100 % of Full Scale Deflection (100 %FSD). A gas over range condition can cause catalytic sensors to operate outside of their working range and incorrectly indicate low gas concentrations when hazardous concentrations may be present.
- **Span gas** is a compressed gas containing a specified concentration of the target gas being sensed.
- **Span** is the gas concentration reading at which calibration is carried out, typically at 50% of full scale.
- **Zero Gas** describes a test gas that has a zero concentration of the target gas being sensed, and it may be a different gas for different sensors.



DANGER

An '**Over Range Warning**' warning may indicate a rare but potentially catastrophic event that must be fully investigated. When an **Over Range Warning** is programmed, TPPR displays a warning on the Touchscreen that requires an additional Reset operation before the alarm may be cleared.

MAINTENANCE

9.2 Calibrating AIM-mV Input Channels

Touchpoint Pro supports routine calibration of mV sensors. TPPR can be programmed to display calibration reminders at calibration intervals, e.g. annually or every six months.

It is compulsory to calibrate the sensor when a channel has been newly commissioned, when the sensor bead current has been changed, or if the system configuration has been deleted.

TPPR warns when the output from a sensor reaches 50% of its initial value and should be replaced. The **First Span calibration option** is used to record the initial output level of a new sensor.

Note: The TPPR mV Analogue Input Module (AIM-mV) forms part of the catalytic bead sensor measuring circuit so all commissioned mV channels remain in **Inhibit** state until they are calibrated.

Note: Details on how to carry out testing can be found in the *Touchpoint Pro Technical Handbook*.



CAUTION

Channel calibration is compulsory after changing the bead current (or catalytic sensor) of an AIM mV channel, and the channel stays in **Inhibit** until this is done.

Disable or inhibit any operations or actions that may result from gas readings before starting this test.



The signal voltage from catalytic sensors reduces over time. Regular recalibration is required to make allowance for these changes.

This slow change is monitored by TPPR and is used to give the sensor life expired warning when the Span value is $\leq 50\%$ of the First Span value.

9.3 Calibrating AIM-mA Input Channel Loops

Touchpoint Pro supports both gas calibration of mA sensor and loop calibration of the transmitter 4-20mA current loop. TPPR can be programmed to display calibration reminders at calibration intervals, e.g. annually or every six months.

In general gas calibration should be carried out at the sensor, using the sensor's inbuilt calibration. Gas calibration of a sensor from TPPR should only be carried out on sensors without this capability.

The procedure is similar. For loop calibration the **Zero** and **Span** (4mA and 20mA) currents should be set using the transmitter's **Force** functions where available.

Note: Details on how to carry out testing can be found in the *Touchpoint Pro Technical Handbook*.



CAUTION

Wherever possible the TPPR mA loop should always be calibrated by forcing signal levels at the sensor / transmitter. Any gas calibration must be carried out at the field device according to the manufacturer's instructions.

Disable or inhibit any operations or actions that may result from gas readings before starting this test.

The Touchpoint Pro controller calibration should not be used to adjust for deficiencies in the sensor / transmitter gas calibration. Failure to observe this can result in significant accuracy errors.

POTENTIAL OPERATING ISSUES

10 System Troubleshooting

This section explains how to deal with problems that may occur during system operation.

Contact Honeywell Analytics for support if required, using the contact details given on the last page of this manual, and having the system details ready (found on the label inside the TPR Controller's enclosure).

10.1 Observed Problem

| Category | Fault / Problem | Possible Cause | Remedial Action |
|---------------|---|--|--|
| Configuration | Unexpected timeout during configuration | When you enter the System Setup menu, a 20 minute configuration timeout is active as well as the user login timeout | To avoid this timeout, send a value to the Touchpoint Pro system within the 20 minute period. If the timeout has occurred, it may be necessary to set the module back to Normal state. Navigate to the System Setup screen, select the module and from the Tools menu select Set Normal state. If this was a first time configuration, all data will have been deleted and the channel decommissioned. If you were editing a channel, any data not sent to the Touchpoint Pro system will be lost. |
| Configuration | 'The Network Initialisation failed; the Ring Network is interrupted. Please check the Ring Network wiring and retry the initialisation once the interruption is rectified.' | The system shows the message before reverting to the Tools menu: | Retry the initialisation once the interruption is rectified. Refer to Ring Troubleshooting for further information. |
| Inhibit Mode | Cannot clear Inhibit from a Channel | It is possible to have more than one inhibit condition active on a channel, and you have to resolve all inhibit conditions before the inhibit can be cleared | Ensure all Inhibits are cleared. Refer to detailed actions below for I/O channels. |
| I/O channels | Channel / alarm is not functioning as expected | Some parameters may be defined in a different way | Check the definitions of parameters in Commissioning, Channel Configuration and verify settings accordingly. |
| I/O channels | Cannot clear Auto Inhibit from channel | System has exited configuration unexpectedly, leaving module in configuration state | Navigate to the System Setup screen, select the module and from the Tools menu select Set Normal state. Alternatively go to System Configuration> System Setup. Select one channel of the module, and select Edit Configuration. Close the popup windows and the module will automatically return to Normal state. |
| Continued... | | AIM mV channel has not yet been calibrated | Calibrate the channel. (For catalytic bead type detectors, the Touchpoint Pro controller is necessary to complete the measuring circuit. Therefore all commissioned mV channels remain in Inhibit state until they are calibrated.) |

POTENTIAL OPERATING ISSUES

| Category | Fault / Problem | Possible Cause | Remedial Action |
|----------------------|---|---|--|
| | | Inhibit Delay is active | Wait for the Inhibit Delay time to elapse. (If the Power-On Delay or Fault Recovery Delay is enabled, the system will remain in Inhibit for a period defined by the Inhibit Delay Time.) Please refer to the <i>TPPR Technical Handbook, Ch. 9.3.14 Inhibit Delay Settings</i> |
| | | Sensor / Transmitter is signalling Inhibit | The Sensor / Transmitter may be in a start-up sequence, or may have been inhibited for maintenance. Refer to the Input Details for that channel from the Inputs screen. |
| mA input channel | There is a discrepancy between the sensor reading and the value displayed by Touchpoint Pro | The mA loop requires calibration | Touchpoint Pro converts the 4-20 mA signal it receives from the sensor to a gas reading. If the discrepancy is significant, re-calibrate the 4-20 mA loop by forcing the sensor output to 4 mA then 20 mA, refer to the <i>TPPR Technical Handbook, Ch. 8.2 Calibrating AIM-mV Input Channels</i> . |
| mA input channel | Error 'Calibration Signal Too High' occurs when calibrating the mA loop | The parameter 'Maximum Span Signal' has been exceeded (default value 20 mA) | Review the configuration of the channel. Under Calibration Settings, verify the value Maximum Span Signal. If necessary, use a lower forced mA value to calibrate the channel. Verify that the transmitter is operating correctly. |
| mA Input channel | Fluctuating input signal | HART communication with the corresponding field device | HART communication with the field device may appear as a fluctuation on the incoming signal. This will clear when HART communication ceases. |
| Modbus | No Modbus Communication | | Verify that the system has a Bus Interface Board (BIB) fitted. Check the wiring between the Control Module terminal blocks TB6 and TB7 and the host computer system port. Try swapping over TDA and TDB. Check that the serial communication configuration parameters of the host computer system and Touchpoint Pro are the same. Ensure that the bus is correctly terminated. If this is the case remove the bus terminators and retry communication. Consider adding network bias resistors. Please refer to <i>TPPR Technical Handbook, Ch. 11 Configuring Modbus</i> , for further details. |
| Modbus | Communication data errors | | Check the data signal wiring is not routed near sources of electrical noise. Check for earth loops. Ensure that the bus is correctly terminated. If this is the case remove the bus terminators and retry communication. Consider adding network bias resistors. If possible use an oscilloscope to examine the signals on the highway and take appropriate corrective action. |
| Modbus | No response from Touchpoint Pro | | Check the address parameter used in requests issued by the host computer system matches the address allocated to the slave node. In multi-drop systems check that all nodes have a unique address. |
| Module configuration | Module is still showing as present and available for configuration in the System Setup | Module has not been properly removed from the system | Follow the instructions to remove a module from the system, see Maintenance, How to Remove or Decommission an I/O Module |

POTENTIAL OPERATING ISSUES

| Category | Fault / Problem | Possible Cause | Remedial Action |
|------------------------------|---|--|---|
| PC Configuration | No PC Configuration SW connection | | Check IP settings, check proper cable connections. The PC should be connected to the Ethernet port of the Touchpoint Pro Control Module. Check that the remote connection port is open. Refer to the <i>TPPR Technical Handbook, Ch.13 Normal Day-to-Day Operation</i> for details. |
| Ring Fault | Ring Fault Message | Ring circuit fault or Module failure | Refer to the <i>TPPR Technical Handbook, Ch.19 Ring Communication Errors</i> |
| Ring Oscillation Fault | Ring faults are present or have occurred on the system when commissioning a module or ring circuit. | This may occur when ring wiring faults are present on two or more unconfigured modules, or un-initialised foreign (unrecognised) modules are present on the ring | Remedial action: 1. Check and correct the ring wiring 2. Remove the unconfigured or foreign modules 3. Clear the ring fault from the system 4. Refit the unconfigured or foreign modules in turn and continue with commissioning 5. Refer the <i>TPPR Technical Handbook, Ch.19 Ring Communication Errors</i> |
| System | System does not start | | Check power supply / wiring, check fuses. Check RCD and UPS/Battery Backup if fitted. |
| System | Ring communication faults observed | | Refer to the <i>TPPR Technical Handbook, Ch.19 Ring Communication Errors</i> . Check the Active Events screen for details of the location of the connection break. or Check the LEDs on each Ring Coupling Module (RCM) in the system. The LED flashes to indicate that data is being received, therefore if an LED is not lit, there is a problem in the preceding section of the ring network. LEDs on the Ring coupling module indicate the presence of an incoming signal and they do not take into account the quality of the incoming signal. Check the cables and connections in the area where the fault is indicated. |
| System | The Event History file is too large to be viewed | The event history file has become too large for the local system memory to process it | Refer to the <i>TPPR Technical Handbook, Ch.13.14 Managing the Integral SD Card</i> and replace the SD Card. To view previously stored information, contact your local service representative for help. |
| System | The system is consistently reporting CCB communication failure | There is a small chance that the CCB has failed | If the problem cannot be remedied by a power cycle, contact your local service representative for help. |
| System | CCB version mismatch | CCB-M and CCB-R have different firmware versions | 1. Ensure both CCBs have the same revision level firmware. 2. Remove CCB with lowest firmware version until replacement can be fitted (Update CCB configuration in controller). |
| User Interface (Touchscreen) | Lost Admin password | User error | A Honeywell authorised engineer is required to create a new Admin user. Forgotten passwords cannot be recovered. |

POTENTIAL OPERATING ISSUES

| Category | Fault / Problem | Possible Cause | Remedial Action |
|------------------------------|---|--|---|
| User Interface (Touchscreen) | Screen does not respond to touch | Internal communication issue | 1) On the front panel, select the Accept and Reset buttons together for >10 s to reset the Communication Board. 2) Contact your service representative if this fails. |
| User Interface (Touchscreen) | Screen does not respond to user input as expected | Screen calibration | The touch screen may require recalibration. |
| GUI (Webserver) | 'Web browser already open' error message | MS Windows limitation: Browser does not fully shut down on exit, or other instances remain open on exit | Use Task Manager to close the browser or select CTRL+ALT+DEL>Start Task Manager>Processes>[Your browser]>End Process Close Task Manager and relaunch your browser. |
| Web Server | No Web Server connection | | Verify that the TPPR has a valid Webserver licence. Check TCP/IP settings, check if the PC network adapter is enabled, check proper cable connections. The Ethernet port of the Touchpoint Pro Control Module should be connected to a network. Please refer to the <i>TPPR Technical Handbook, Ch. 5.2 Cabling Requirements</i> , for further information. |
| Web Server | Communication with the Controller is lost | The Touchpoint Pro Controller is busy, or the network has been interrupted. | If possible, check the TPPR Touchscreen for any instruction or detailed error message. A system operation such as power up, backup or restore may be in progress. Allow time for completion and retry. |
| Web Server | Slow / intermittent response from the Touchpoint Pro system | The Web Server supports 5 concurrent web clients, however it does not restrict further users from connecting | Reduce the number of web clients to five or below. |

Table 14. Potential Issues

10.2 Other Issues

10.2.1 Modules Reporting a Fault

If the system detects a module fault, the fault will be reported on the screen and the module's LED will change colour to orange.

If the fault is transient in nature – possibly due to low power supply voltage or to ring communication problems – the module will return automatically to normal operation when the fault is cleared.

When the system detects a module fault, that module will be set to a safe state. If this happens, the module stops communicating on the ring and takes its inputs / outputs to the defined 'safe' state e.g. it turns off mV bead current and takes relays to a power-off state. Refer to the *TPPR Technical Handbook, Ch. 19 Ring Communication Errors*, for further information.

A failed module will generate ring fault reports, module fault reports and channel fault reports. The channels either side of it will also report lost communications, but will not be shown as faulty. Refer to the *TPPR Technical Handbook, Ch. 19 Ring Communication Errors*, for further information.

The module should only be replaced if the fault is *not* due to low power or a ring problem in another part of the system. Contact your local service representative for help if required.

Note: it may be possible to restore module operation by physically removing and refitting the module to disrupt its power supply. However, you should contact your service representative for advice as the recovery may only be temporary.

POTENTIAL OPERATING ISSUES

11 Error Codes

The TPPER Controller may generate an error message if an exception is encountered. Each message has a code number that is listed, with its explanations and suggested remedy, in the table below.

Key:

CCB = Control Centre Board; **COB** = Communication Board; **I/O** = Input/Output Module; **UDID** = Unique Device Identifier.

Honeywell Service Centre details are on the back page, and your local service contact may be found in: **Configuration Settings > System Status > Tool Box > Global Settings > Service Contact Settings.**

| Error Code | Message | Possible Cause | Remedial Action | Sys Fail Relay | Sys Fault Relay |
|------------|--|---|--|----------------|-----------------|
| 1 | Not used. | — | — | | |
| 2 | Operation failed; invalid frame length. Please retry the operation. If the problem persists, please contact your local service representative. | The COB has a communication issue | 1. Retry the operation. 2. If still unsuccessful, reboot the COB by pressing [Accept + Reset] for 10 s. 3. If the error still has not cleared, cycle the system power off and on. 4. Contact your local service representative if the problem persists. | | X |
| 3 | Operation failed; invalid source address. Please verify that the current COB software and CCB firmware revisions are compatible. | A software or firmware update is not compatible with other installed components | 1. Refer to the Help screen to confirm the currently installed version of software and firmware. Contact your Service Representative. | | X |
| 4 | I/O Module parameter write failed; UDID does not match. | The CCB may not recognise the module type | 1. Initialise the ring network and try again. 2. If the error persists, contact your Service Representative. | | X |
| 5 | Not used. | — | — | | |
| 6 | Operation failed; invalid channel type. | Refer to Error 2 | Refer to Error 2 | | X |
| 7 | Operation failed; invalid request type. | ————//———— | ————//———— | | |
| 8 | Operation failed; invalid command code. | Refer to Error 2. Can also occur due to non-compatible COB Software and CCB Firmware versions | ————//———— | | |
| 9 | Operation failed; invalid object type. | Refer to Error 2 | ————//———— | | |
| 10 | Operation failed; invalid object identifier. | ————//———— | ————//———— | | |
| 11 | Operation failed; invalid parameter identifier. | Refer to Error 2. Can also occur due to non-compatible COB Software and CCB Firmware versions | ————//———— | | |
| 12 | Operation failed; wrong parameter identifier. | ————//———— | ————//———— | | |

POTENTIAL OPERATING ISSUES

| Error Code | Message | Possible Cause | Remedial Action | Sys Fail Relay | Sys Fault Relay |
|------------|---|--|--|----------------|-----------------|
| 13 | Operation failed; parameter is read-only. | Refer to Error 2 | ————//———— | | |
| 14 | Login session has expired or has been ended by another user. | A user login will time out after 20 minutes of inactivity, or another user may be logged in via one of the alternative interfaces (local Touchscreen or PC Configuration Software) | 1. Check if another user is logged in. 2. If your requirement takes priority, you have the option to terminate the existing (other user's) session. | | |
| 15 | Operation failed; invalid transaction identifier. | Refer to Error 2 | Refer to Error 2 | | |
| 16 | Flash memory write operation failed. | During configuration, the CCB was unable to write a value into the non-volatile memory | 1. Retry the operation. 2. If the error has not cleared, if possible cycle the power to the system. 3. If the problem persists, please contact your local service representative. | X | X |
| 17 | Operation failed; invalid module identifier. | Refer to Error 2 | Refer to Error 2 | | |
| 18 | Operation failed; invalid channel identifier. | ————//———— | ————//———— | | |
| 19 | Operation failed; invalid physical channel number. | ————//———— | ————//———— | | |
| 20 | Module ID could not be assigned, because it is already in use by another module. | Each module on the system must have a unique module ID (e.g. M03) | Select a different Module ID | | |
| 21 | Operation failed; wrong number of parameter identifiers. | Refer to Error 2 | Refer to Error 2 | | |
| 22 | Not used. | — | — | | |
| 23 | Operation failed; Module ID does not exist. | May occur during configuration or changeover of a module | 1. Re-initialise the ring network 2. Retry the operation 3. If the error has not cleared, if possible cycle the power to the system. 4. If the problem persists, please contact your local service representative | | |
| 24 | I/O Module cannot be de-commissioned, because one or more channels on this module are commissioned. Please de-commission all channels before de-commissioning the module. | All channels of a module must be de-commissioned before a module can be de-commissioned | 1. De-commission all channels on the I/O Module. 2. Retry the operation. | | |
| 25 | Operation failed; Module ID does not match. | Refer to Error 23 | Refer to Error 23 | | |
| 26 | Operation failed; an I/O Module with the same UDID does already exist on the system. | Each TPPR component has a unique identifying code. | Refer to Error 23 Contact your local representative to obtain a replacement module. | | X |

POTENTIAL OPERATING ISSUES

| Error Code | Message | Possible Cause | Remedial Action | Sys Fail Relay | Sys Fault Relay |
|------------|---|--|---|----------------|-----------------|
| 27 | Operation failed; the intended operation is not allowed for the current I/O Module state. | These errors may occur if configuration of the module or its channels was interrupted, leaving the module in an undetermined state | Depending on the intended operation, either: Restart the configuration for the module, or from the configuration screen, remove the module and restart commissioning, or Force the module to Normal state | | |
| 28 | The I/O Module could not be found on the network (unknown UDID). | Refer to Error 23 | Refer to Error 23 | | |
| 29 | The I/O Module could not be found on the network (unknown SDID). | ————//———— | ————//———— | | |
| 30 | Operation failed; I/O Module state is invalid. | Refer to Error 27 | Refer to Error 27 | | |
| 31 | State Change operation failed; could not communicate with I/O Module. | Potential issue with the ring network connection, or damaged/faulty I/O Module | <ol style="list-style-type: none"> 1. Check the Active Events screen for any reported failure of the ring communication. In this case, refer to Error 37 – Ring communication failed. 2. Check that the I/O Module is properly seated on the DIN rail. 3. If the error persists, remove the module and check for any damage to the connector on the DIN rail. 4. In this case, it may be possible to move the module to another slot. 5. If the connector is damaged, contact your local representative to obtain a replacement DIN rail PCB assembly. 6. If no damage is apparent to the connector and the module fails to operate in another slot, then the module may be faulty. Follow the procedure in Maintenance, Replace an I/O Module to replace it. | | |
| 32 | The user could not be added. A user with the same name already exists on the system. | User already exists | Create the new user with a different name. | | |
| 33 | User could not be added; maximum number of 20 users reached. | The system has the maximum number of users | Remove another user so that the new user can be created. | | |
| 34 | The Username/Password is incorrect, please try again. | Incorrect user name, password or access level | <ol style="list-style-type: none"> 1. Check that the user name and password are correct. 2. Confirm that the user has the required access level (see summary in User Interface, Access Levels). 3. If necessary, create a new user with the appropriate access level. | | |
| 35 | The Username/Password is incorrect, please try again. | ————//———— | ————//———— | | |
| 36 | Access denied; your current access level does not allow the intended operation. | ————//———— | ————//———— | | |

POTENTIAL OPERATING ISSUES

| Error Code | Message | Possible Cause | Remedial Action | Sys Fail Relay | Sys Fault Relay |
|------------|--|---|---|----------------|-----------------|
| 37 | Ring communication failed - please check proper ring network wiring and try again. | There is an issue with the ring network connection | Refer to the <i>TPPR Technical Handbook, Ch.19 Ring Communication Errors</i> . 1. If the error occurred during normal operation (i.e. not configuration), check the Active Events screen for details of the location of the connection break. 2. Check the LEDs on each Ring Coupling Module (RCM) in the system. The LED indicates that data is being received, therefore if an LED is not lit, there is a problem in the preceding section of the ring network. 3. Check the cables and connections in the area where the connection break fault is indicated. | | X |
| 38 | System interaction command failed; please try again. | An error occurred during the system interaction | 1. Retry the operation. 2. If the error has not cleared, if possible cycle the power to the system. 3. If the problem persists, please contact your local service representative. | | |
| 39 | Operation failed; wrong alarm identifier. | ————//———— | ————//———— | | |
| 40 | Flash erase operation failed. | The CCB was unable to erase a value from the non-volatile memory | 1. Retry the operation. 2. If the error has not cleared, if possible cycle the power to the system. 3. If the problem persists, please contact your local service representative. | X | X |
| 41 | Not used. | — | — | | |
| 42 | Operation failed; maximum file size exceeded. | An error occurred during firmware / software update or configuration backup / restore | 1. Check that the correct file is being used for the update / restore operation. 2. Retry the operation. 3. If still unsuccessful, on the front panel, press the Accept and Reset buttons together for 10 s, which will restart the COB. 4. Retry the operation. 5. If the error has not cleared, if possible cycle the power to the system. 6. If the problem persists, please contact your local service representative. | | |
| 43 | Operation failed; file ID mismatch - firmware update failed. | ————//———— | ————//———— | | |
| 44 | Operation failed; file block out of sequence - firmware update failed. | ————//———— | ————//———— | | |
| 45 | Operation failed; invalid file block size - firmware update failed. | ————//———— | ————//———— | | |
| 46 | Operation failed; CRC mismatch - firmware update failed. | ————//———— | ————//———— | | |
| 47 | Firmware could not be applied - firmware update failed. | ————//———— | ————//———— | | |
| 48 | Configuration restore operation failed. | ————//———— | ————//———— | | |

POTENTIAL OPERATING ISSUES

| Error Code | Message | Possible Cause | Remedial Action | Sys Fail Relay | Sys Fault Relay |
|------------|--|--|---|----------------|-----------------|
| 49 | Input channel cannot be de-commissioned, because it is used in the C&E logic. Please remove the input channel first from the corresponding output channel C&E and retry the de-commission operation. | TPPR will not allow the removal of an input from the Cause and Effect matrix | <ol style="list-style-type: none"> 1. Identify the output channel(s) that the input channel is linked to. 2. Modify the Cause and Effect matrix for that channel to remove the input channel. 3. Retry the de-commissioning operation. | | |
| 50 | Invalid calibration status. | Channel requires calibration, or has not been successfully calibrated | <ol style="list-style-type: none"> 1. Please retry the operation. 2. If still unsuccessful, on the front panel, press the Accept and Reset buttons together for 10 s, which will restart the COB. 3. If the error has not cleared, if possible cycle power to the system. 4. Contact your local Service Representative if the problem persists. | | |
| 51 | Zero gas calibration failed - zero signal too low. | The level at which the channel is trying to calibrate zero is outside the configured limits | <ol style="list-style-type: none"> 1. For a mA channel, calibration should always be done by forcing the output from the sensor where the facility exists. Check the configured limits on zero and span gas calibration and ensure that the forced mA value is within the limits. 2. For a mA channel where the sensor has no facility to force the output, consult the manufacturer's instructions and carry out a calibration at the sensor. 3. For a mV channel, there may be a problem with the sensor or the calibration gas. Consult the manufacturer's instructions. 4. Contact your local Service Representative if the problem persists. | | |
| 52 | Zero gas calibration failed - zero signal too high. | The level at which the channel is trying to calibrate zero is outside the configured limits | // | | |
| 53 | Span gas calibration failed - span signal too low. | The level at which the channel is trying to calibrate span is outside the configured limits | <p>As above.</p> <p>If carrying out a cross calibration, check the calculated figure using the sensor documentation.</p> | | |
| 54 | Span gas calibration failed - span signal too high. | The level at which the channel is trying to calibrate span is outside the configured limits | <p>As above.</p> <p>If carrying out a cross calibration, check the calculated figure using the sensor documentation.</p> | | |
| 55 | Gas calibration failed - sensor lifetime exceeded. The sensor sensitivity has fallen to below 50% of its original value; please replace the sensor. | TPPR monitors the performance of mV sensors relative to their first span calibration. If the gas response falls below 50% of the original value this error occurs. | <ol style="list-style-type: none"> 1. Contact your local service representative to schedule a sensor replacement. 2. When the replacement sensor has been fitted, repeat calibration in accordance with the instructions in chapter 6, using the 'First Span' function. | | |

POTENTIAL OPERATING ISSUES

| Error Code | Message | Possible Cause | Remedial Action | Sys Fail Relay | Sys Fault Relay |
|------------|--|--|---|----------------|-----------------|
| 56 | Entered span gas concentration is out of range - please edit and try again | The span gas selected is not within the configured limits | <ol style="list-style-type: none"> 1. Check the configured limits for span gas concentration. 2. Obtain an alternative span gas that is within the limits. 3. Retry the operation. | | |
| 57 | Operation failed; invalid object type | There has been a communication error between the CCB and COB | <ol style="list-style-type: none"> 1. Please retry the operation. 2. If still unsuccessful, on the front panel, press the Accept and Reset buttons together for 10 s, which will restart the COB. 3. If the error has not cleared, if possible cycle the power to the system. 4. If the problem persists, please contact your local service representative. | | X |
| 58 | Operation failed; CRC calculation timeout | There has been a file transfer error between the CCB and COB | <ol style="list-style-type: none"> 1. Please retry the operation. 2. If still unsuccessful, on the front panel, press the Accept and Reset buttons together for 10 s, which will restart the COB. 3. If the error has not cleared, if possible cycle the power to the system. 4. If the problem persists, please contact your local service representative. | | X |
| 59 | Operation failed; a session has already been opened by another user | Another user may be logged in via one of the alternative interfaces (local Touchscreen or PC Configuration Software) | <ol style="list-style-type: none"> 1. Check if another user is logged in. 2. If your requirement takes priority, you have the option to terminate the existing (other user's) session. | | |
| 60 | The session has expired - new user login required | A user login will time out after 20 minutes of inactivity | The system will automatically request a new login | | |
| 61 | Not used | — | — | | |
| 62 | Not used | — | — | | |
| 63 | Operation failed; CRC error occurred for safe data. | Refer to Error 2 | Refer to Error 2 | X | X |
| 64 | Operation failed; CRC error occurred for non-safe data. | ————//———— | ————//———— | | X |
| 65 | Operation failed; session does not exist; user login required | User login is required before carrying out the intended operation | The system automatically requests a new login. The user may have been remotely logged out by another user. | | |
| 66 | Operation failed; CCB did not respond within the expected time interval. | Refer to Error 2 | Refer to Error 2 | | |
| 67 | Configuration read / write request failed; FLASH memory operation timeout | During configuration, the CCB was unable to read or write a value from / to non-volatile memory | <ol style="list-style-type: none"> 1. Retry the operation. 2. If the error has not cleared, if possible cycle the power to the system. 3. If the problem persists, please contact your local service representative. | X | X |

POTENTIAL OPERATING ISSUES

| Error Code | Message | Possible Cause | Remedial Action | Sys Fail Relay | Sys Fault Relay |
|------------|---|---|---|----------------|-----------------|
| 68 | The Network Initialisation failed; the Ring Network is interrupted. Please check the Ring Network wiring as explained in the user manual and retry the initialisation once the interruption is rectified. | The system will not allow you to initialise the network if a ring break is present | Refer to the <i>TPPR Technical Handbook, Ch.19 Ring Communication Errors</i> . 1. Check the Active Events screen for details of the location of the connection break. 2. Check the cables and connections in the area where the connection break fault is indicated (also see Error 37). 3. Ensure that details of the Ring Network break error have gone from the Active Events screen (problem is resolved) 4. Return to the System Setup screen and retry the Ring Initialisation operation. | | |
| 69 | Not used | — | — | | |
| 70 | Cannot clear Inhibit because the channel has been inhibited automatically | A mV input channel has not yet been calibrated or channel configuration was interrupted, or the inhibit delay time is active, or the sensor/transmitter is signalling inhibit | 1. For a mV channel, calibrate the channel (see Commissioning, Calibrating a mV input channel). 2. If this is not the cause, go to System Configuration, then System Setup. 3. Select the module with the inhibited channel, and select Normal State. 4. If this is not successful, go to Tool Box then Event History to check if an Inhibit Delay Time is active. The inhibit condition will clear after the Delay Time has expired. 5. If there is no Delay Time active, then investigate the conditions at the sensor/transmitter. | | |
| 71 | Cannot reset because the alarm, fault or warning is still active | The field device is still signalling an active alarm, fault or warning | Investigate the conditions at the field device. | | |
| 72 | One or more events are still active and cannot be reset | Cleared alarms, faults or warnings have been reset, but others are still active | Some events (for example Over Range Warning) may give multiple alarms and these must all be investigated and cleared at the respective field devices before attempting to reset again. | | |
| 73 | Replace operation cannot be performed; module type of new module is not compatible. | Replacement module is incorrect type or not recognised by the CCB | 1. Check and confirm that the replacement module is of the correct type. 2. Re-initialise the ring network and try again. 3. If the error persists, update the CCB firmware. 4. If the problem persists, please contact your local service representative. | | |
| 74 | Not used | — | — | | |
| 75 | Not used | — | — | | |
| 76 | Not used | — | — | | |
| 77 | Not used | — | — | | |
| 78 | Not used | — | — | | |

POTENTIAL OPERATING ISSUES

| Error Code | Message | Possible Cause | Remedial Action | Sys Fail Relay | Sys Fault Relay |
|------------|--|--|--|----------------|-----------------|
| 79 | The Input Module cannot be commissioned: The maximum number of 16 Input Modules has already been commissioned on the system. | TPPR has a maximum capacity of 16 Input and 32 Output Modules | If more channels than 64 inputs and 128 outputs are required an additional TPPR system is needed. Contact your local representative to discuss your requirements | | |
| 80 | The Output Module cannot be commissioned: The maximum number of 32 Output Modules has already been commissioned on the system. | ————//———— | ————//———— | | |
| 81 | Invalid test sequence | CCB receives wrong Test sequence for Relay tests | Refer to Error 2 | | |
| 82 | The user could not be added; invalid user name. Please choose a different user name and try again. | The user name must be 4 to 20 characters long | Please choose a user name that meets the requirements and try again | | |
| 83 | Kill Session denied Configuration Backup / Restore in Progress | User has attempted to end a session for the PC configuration SW while a CCB configuration backup or restore is in progress | Retry after the configuration restore operation is completed. Check with the user at the local controller that it is acceptable to log in from remote PC. | | |
| 84 | Kill Session denied CCB Firmware update in Progress. | User has attempted to end a session for the PC configuration SW while a CCB firmware update is in progress | Retry after the firmware download operation is completed. Check with the user at the local controller that it is acceptable to log in from remote PC. | | |
| 85 | The controller needs a restart to proceed further. Please power cycle the controller and try again. | The system is being updated and needs a power cycle to continue. | Cycle the power supply off, wait 15 to 20 seconds and then power on again | | |
| 86 | System is running in test mode. | One of the three test modes is active, and other operations are restricted or not permitted | Wait until testing is complete. If necessary, exit Test Mode to carry out the required operation. | | X |
| 87 | Not used | — | — | | |
| 88 | Operation failed; Save Calibration Failed. | TPPR was unable to save the sensor calibration | Please retry the operation. | | |
| 89 | Operation failed; Channel Wiring Fault. | TPPR cannot detect that a sensor is connected to the channel or it has detected incorrect wiring | Check all field wiring to the sensor and correct any problems | | X |
| 90 | Operation failed; Bead Fault. | TPPR cannot read the bead current from the connected mV sensor | Check all field wiring to the sensor. It is possible that the sensor has failed, Refer to the manufacturer's instructions | | X |

POTENTIAL OPERATING ISSUES

| Error Code | Message | Possible Cause | Remedial Action | Sys Fail Relay | Sys Fault Relay |
|------------|--|--|---|----------------|-----------------|
| 91 | Operation failed; system is running in test mode. | One of the three test modes is active, and other operations are restricted or not permitted | Wait until testing is complete. If necessary, exit Test Mode to carry out the required operation. | | |
| 92 | Calculation error | A calculation error has occurred during calibration, for example Zero and SPAN calibration done with the same gas input | Retry the calibration. Ensure that the values for zero and span gas are entered correctly. | | |
| 93 | Operation failed; module list is mismatching | The Module list detected and the Module list in Backup file are not the same | Ensure that the correct backup file for the system is being used. Retry the operation. | | |
| 94 | Operation failed; please perform ring initialisation first | Faulty CCB has been replaced by new CCB and configuration restore has been attempted | First initialise the ring network, then try again | | |
| 95 | The username/password is incorrect, please try again | User credential mismatch | Verify user name and password and try again. Usernames and passwords are case sensitive. | | |
| 96 | Not used | — | — | | |
| 97 | Cannot open session because a channel is being calibrated | A user at the local Touchscreen is doing calibration when a PC Configuration Software user tries to open a configuration session | Wait for the calibration to be completed. Check with the user at the local controller that it is acceptable to log in from remote PC. | | |
| 98 | Cannot start calibration because a configuration session on PC is in progress | Calibration is attempted while a configuration session is in progress | Close the configuration session and retry calibration. Contact the remote user to agree access. | | |
| 99 | Operation failed; Brownout Fault | Brown out fault (low power supply voltage) is set for a module and configuration is attempted for this module / channels of module | Check that power supply voltage is correct, and that current limit is adequate. Remedy the fault and then do configuration. | | X |
| 100 | Replace operation cannot be performed - no free I/O Modules available. Please add a compatible I/O Module and initialize the ring network again. | The replacement module has not been detected on the network | Refer to section Maintenance, Replacing an I/O Module for the full procedure. | | |
| 101 | Ring initialisation has failed. Please cycle the power to the system | Ring Network Initialisation has failed | 1. Power cycle the TPPR system 2. Return to the System Setup screen and retry the Ring Initialisation operation. | | |
| 102 | Initialisation timeout has occurred. Please cycle the power to the TPPR system. | An internal system timeout has occurred | Power cycle the TPPR system | | |

POTENTIAL OPERATING ISSUES

| Error Code | Message | Possible Cause | Remedial Action | Sys Fail Relay | Sys Fault Relay |
|------------|--|---|---|----------------|-----------------|
| 103 | Not used | — | — | | |
| 104 | Operation failed; response result failure | Internal communication error | <ol style="list-style-type: none"> 1. Please retry the operation. 2. If still unsuccessful, on the front panel, press the Accept and Reset buttons together for 10 s, which will restart the COB. 3. If the error has not cleared, if possible cycle the power to the system. 4. If the problem persists, please contact your local service representative. | | |
| 105 | Operation failed; response timeout | —//— | —//— | | |
| 106 | Operation failed; CRC error | —//— | —//— | | |
| 107 | Operation failed; session expired | A user login will time out after 20 minutes of inactivity | The system will automatically request a new login | | |
| 108 | CCB-COB communication failed. | Refer to Error 2 | Refer to Error 2 | | X |
| 109 | Operation failed; CCB is not responding. | —//— | —//— | | X |
| 110 | Channel cannot be commissioned; no free Channel ID available. | Each TPPR system is limited to 64 input and 128 output channels maximum | Contact your local representative if you want to discuss any requirements above this limit. | | |
| 111 | Operation failed; invalid command code received from CCB. | Refer to Error 2 | Refer to Error 2 | | |
| 112 | Module cannot be commissioned. You have exceeded the maximum number of 48 I/O modules. Use the Remove Module or Replace Module function in the System Configuration. | Each TPPR system is limited to 16 Input plus 32 Output Modules maximum | Contact your local representative if you want to discuss any requirements above this limit. | | |
| 113 | Not used | — | — | | |
| 114 | Restore operation failed - backup file could not be found | An error occurred during configuration restore | <ol style="list-style-type: none"> 1. Check that you have specified the correct memory device, SD or USB. 2. Check that the correct file is being used for the restore operation, and is saved as \Hard Disk\TPPR Configuration\TPPR_Config_<SystemID>_<nnn>.bin, where nnn is 001 to 999 3. Retry the operation. 4. On the front panel, press the Accept and Reset buttons together for 10 s, which will restart the COB. 5. Retry the operation. | | |
| 115 | Operation cannot be performed - please insert SD Card! | — | <ol style="list-style-type: none"> 1. Check that the SD Card has enough free memory available for the operation. 2. Check that it is correctly inserted in the socket. 3. Retry the operation. | | X |

POTENTIAL OPERATING ISSUES

| Error Code | Message | Possible Cause | Remedial Action | Sys Fail Relay | Sys Fault Relay |
|------------|---|---|---|----------------|-----------------|
| 116 | Operation failed; transaction could not be closed | Refer to Error 2 | Refer to Error 2 | | |
| 117 | Operation failed; response parsing failure | ————//———— | ————//———— | | |
| 118 | The System ID has not been programmed. Contact your system administrator or service centre. | The System ID is not stored in the system. | 1. Locate and re-enter the correct System ID. 2. Allocate and enter an ID if none allocated. Default is controller serial number. (Administrator access is required for both.) 3. Contact your service representative. The gas detection system will continue to work correctly, but backups cannot be restored until the correct System ID is programmed. | | |
| 242 | The channel has reported a fault | Clear the fault and try again | Clear the fault and try again | | |
| 245 | Operation Failed – fault recovery delay is active | Sensor is still warming up | Retry after sensor fault recovery delay has timed out. | | |
| 246 | Operation Failed – power-up delay is active | Sensor is still warming up | Retry after sensor power up delay has timed out. | | |
| 247 | Operation Failed – module is in configuration state | Timeout while editing configuration | Navigate to System Setup screen and set module to Normal state from menu. | | X |
| 249 | Not used | — | — | | |
| 250 | Operation failed; kill session denied as CCB is busy performing critical operation | A user has attempted to end a session while the CCB is updating memory as result of a configuration request | Try again after the memory update is completed. Check with the user at the local controller that it is acceptable to log in from remote PC. | | |
| 252 | Operation failed; Redundant CCB failed; power cycle the controller and try again | Redundant CCB failed during firmware update | 1. Replace the CCB-R. 2. Remove failed CCB until replacement can be fitted. (Update CCB configuration in controller.) 3. Contact your local service representative. | | X |
| 253 | STEL timer is reset by this operation | Channel inhibit resets the STEL time-weighted average calculations | This is a warning message to notify the user that the STEL calculation is resetting | | |
| 254 | Not used | — | — | | |
| 255 | Operation failed | — | Retry the operation. If the problem persists, contact your local service representative. | | |
| 400 | Unknown error code received from CCB. Please retry the operation. If the problem persists, please contact your local service representative | — | Please retry the operation. If the problem persists, please contact your local service representative. | | X |

Table 15. Error Codes and Remedies

POTENTIAL OPERATING ISSUES

12 Other Potential Issues

12.1 Batteries Fail to Come Online

Check the battery isolator switch and the battery fuse if the batteries fail to come online when mains power is interrupted. See the *Touchpoint Pro Technical Handbook* for further information.

12.2 DC-UPS Shows that Batteries are Failing

The backup batteries will deteriorate over time, and their life is partially determined by their ambient local environment. They should be replaced when periodic inspection of the DC-UPS battery condition indicators show yellow or red.

See the *Touchpoint Pro Technical Handbook* for further information.

12.3 Module Faults

Modules are designed to periodically self-test and will shut down if they detect a fault or suffer a catastrophic failure, and they will stop communicating on the ring circuit. This will typically be reported as a ring fault in addition to a module fault.

In the event of a module shut-down, modules either side of the faulty module will divert communication from the primary circuit (Ring A) to the secondary circuit (Ring B), and will report Ring faults. In addition, all commissioned channels on the faulty module will report a channel fault. The remaining modules and channels will continue to work correctly.

The table extract below is from an actual event log and it shows that Module M23 has failed.

| | | | | |
|------|---------------------|--------------|--------------------------|--------------|
| M23 | 16/11/2015 12:34:52 | Module M23 | Module M23-Ring | System Fault |
| o061 | 16/11/2015 12:34:52 | <Ch Tag> | Ring Communication Error | Fault |
| o062 | 16/11/2015 12:34:52 | <Ch Tag> | Ring Communication Error | Fault |
| o063 | 16/11/2015 12:34:52 | <Ch Tag> | Ring Communication Error | Fault |
| o064 | 16/11/2015 12:34:52 | <Ch Tag> | Ring Communication Error | Fault |
| | 16/11/2015 12:34:53 | System Fault | Ring : Module M22 | System Fault |
| | 16/11/2015 12:34:53 | System Fault | Ring : Module M24 | System Fault |

Table 16. Example of a Ring Fault Event Log

The table above indicates that Module M23 to the Ring is causing Ring Communication Errors and that the Ring circuits are broken between Modules M22 and M24. The event display would be similar if the faulty module is the first or last module on the Ring, but it might also indicate a ring fault between the module and the CCB.

Note: Channels associated with a faulty module will also be reported as faulty, but these events may be ignored as the parent module has shut-down and is unable communicate any channel data.

See the *Touchpoint Pro Technical Handbook* for further information, or ask your Service Contact for advice.

12.4 Modules Reporting a Fault

If the system detects a module fault, the fault will be reported on the screen and the module's LED will change colour to orange.

If the fault is transient in nature – possibly due to low power supply voltage or to ring communication problems – the module will return automatically to normal operation when the fault is cleared.

When the system detects a module fault, that module will be set to a safe state. If this happens, the module stops communicating on the ring and takes its inputs / outputs to the defined 'safe' state e.g. it turns off mV bead current and takes relays to a power-off state.

A failed module will generate ring fault reports, module fault reports and channel fault reports. The channels either side of it will also report lost communications, but will not be shown as faulty.

See the *Touchpoint Pro Technical Handbook* for further information, or ask your Service Contact for advice.

POTENTIAL OPERATING ISSUES

12.5 Spurious Fault Reporting

Due to external factors some reported faults may be spurious, variable or unstable, typically showing high numbers of faults that are difficult to locate or diagnose. E.g. if a short or open circuit occurs in a remote location the communication ring may appear to operate normally or ring operation and fault reporting may be intermittent and transient. These faults can be difficult to diagnose, especially if a cable has degraded over time and/or where moisture ingress may be a factor.

If in doubt:

- Check if the occurrences correspond to ambient conditions such as rain, high humidity or dew point.
- Check the connections and wiring at remote cabinets and cable joints, and then work backwards toward the Controller while checking for degraded, damaged or shorted wiring, particularly within exposed cable runs.
- Refer to the *TPPR Technical Handbook, Ch.19.4 Ring Fault Diagnostics and Debugging Techniques*.

POTENTIAL OPERATING ISSUES

13 Further Assistance and Training

It is not always possible or desirable to include all of the possible technical or help issues. Honeywell has a team of dedicated technical specialists available to handle technical support or general help issues that are not covered in this guide, and who can help you to organise User or Field Service Engineer training if required.

Honeywell Service Centre details are on the back page of this manual.

Please have the following information to hand (**Tool Box>Help>About**):

- A description of the problem, including the error code and any steps you have taken to resolve it.
- The serial number of the TPPR system.
- CCB firmware version.
- COB firmware version.
- Local UI version.
- Webserver version.
- Modbus version (if applicable).

Note: In addition to basic and advanced TPPR training, Honeywell Analytics can provide training on the installation and testing of Honeywell sensors and detectors.

CERTIFICATION

14 EU Declaration of Conformity

A full EU declaration of conformity is available on the CD accompanying the product. This document lists the European Standards with which the TPPR complies.

WARNING

Only the combustible gas portion has been assessed for performance in accordance with CSA 22.2 No. 152 & FM 6310 / 20.
 CSA performance is only valid when connected to Honeywell Model 705 Catalytic Gas Detectors or suitably approved 4 – 20 mA Gas Detectors.

AVERTISSEMENT

Seule la partie de gaz combustible a été évaluée en ce qui concerne la performance en conformité avec la norme CSA 22.2 No. 152 & FM 6310/20
 La performance en conformité avec la CSA est valide uniquement lorsque l'appareil est connecté aux détecteurs de gaz catalytiques Honeywell modèle 705 ou à des détecteurs de gaz 4 - 20 mA dûment approuvés.



14.1 Applicable National and International Standards

The TPPR systems described in this manual are declared to conform to the following National and International Standards when installed and operated in accordance with the Manufacturer's specifications and stipulations:

| Ordinary Location Standards | Zone 2 Div. 2 Hazardous Location Standards | European Performance Approvals | Functional Safety |
|---|---|---|-------------------|
| CAN/USA – C22.2 No. 61010-1 CSA 22.2 No. 152 UL Std – No. 61010-1 EN/IEC 61010-1 FM 6310 & 6320 | ANSI/ISA –12.12.01 CAN/CSA C22.2 No. 60079-0 CAN/CSA C22.2 No. 60079-15 CSA C22.2 No. 0-M CSA C22.2 No. 213-M EN/IEC 60079-0 EN/IEC 60079-15 UL 60079-0 UL 60079-15 FM 6310 & 6320 | EN 60079-29-1 EN 50104 EN 45544 EN 50271 | IEC 61508 |

Table 17. Applicable National and International Standards

CERTIFICATION

14.2 National and International Certificates for Zone 2 Div. 2

The TPPR Zone 2 Div. 2 Systems and System Components hold the following National and International Certificates and Certification Codes:





| Description | Certificates |
|---|--|
| Remote Wall Mount Zone 2/Div. 2 Enclosure and ROM (ATEX/IECEX)  | II 3G Ex nA nC IIC T4 Gc (ROM) Tamb -40 °C to +70 °C (Enclosure) Tamb -40 °C to +xx °C* * See Rating Plate |
| Remote Wall Mount Zone 2/Div. 2 Enclosure and ROM (CSA US/CAN)  | Class I, Div. 2, ABCD T4 Class I, Zone 2, AEx nA nC IIC T4 Class I, Zone 2, Ex nA nC IIC T4 (ROM) Tamb -40 °C to +70 °C (Enclosure) Tamb -40 °C to +xx °C* * See Rating Plate |
| AIM mA, AIM mV, DIM, RCM and Backplanes (ATEX/IECEX)  | II 3G Ex nA IIC T4 Gc Tamb -40 °C to +70 °C |
| AIM mA, AIM mV, DIM, RCM and Backplanes (CSA US/CAN)  | Class I, Div. 2, ABCD T4 Class I, Zone 2, AEx nA IIC T4 Class I, Zone 2, Ex nA IIC T4 Tamb -40 °C to +70 °C |
| Remote Wall Mounted Zone 2/Div. 2 Enclosure | SIRA 15ATEX4034X IECEX SIR15.0021X CSA 70030437 |
| AIM mA | SIRA 15ATEX4028U IECEX SIR15.0015U CSA 70004992 |
| AIM mV | SIRA 15ATEX4029U IECEX SIR15.0016U CSA 70025468 |
| DIM | SIRA 15ATEX4030U IECEX SIR15.0017U CSA 70025478 |
| ROM | SIRA 15ATEX4031U IECEX SIR15.0018U CSA 70025950 |
| RCM | SIRA 15ATEX4032U IECEX SIR15.0019U CSA 70025951 |
| Backplanes | SIRA 15ATEX4033U IECEX SIR15.0020U CSA 70025953 |

Table 18. National and International Certificates

14.3 European Performance Approval (DEKRA Exam) for Systems

TPPR has been approved by DEKRA Exam for use in the measurement of oxygen as well as combustible and toxic gases. The certification marking that is applied to the product is shown below:

 Ex II (1) GD

BVS 16 ATEX G 002 X for EN 60079-29-1, EN 50104 and EN 50271

PFG 16 G 002 X for EN 50104, EN 45544-1/2/3 and EN50271

CERTIFICATION

14.3.1 Approved Components

The following system components have been tested and approved by DEKRA Exam

| | |
|---------------------------|-------------|
| CCB & CCB-R | TPPR-V-2120 |
| COB | TPPR-P-2110 |
| Local HMI | TPPR-V-0852 |
| CM Motherboard | TPPR-P-2100 |
| Bus Interface Board | TPPR-V-2130 |
| Backplane 10 Way | TPPR-P-0540 |
| Backplane 9 Way | TPPR-P-0530 |
| Backplane 7 Way | TPPR-P-0525 |
| Backplane 5 Way | TPPR-P-0520 |
| 19" Rack (with HMI) | TPPR-V-0602 |
| 19" Rack (remote) | TPPR-V-0612 |
| Wall Mount Remote (Small) | TPPR-V-1215 |
| AIM mA | TPPR-V-1000 |
| AIM mV | TPPR-V-1010 |
| DIM | TPPR-V-1030 |
| ROM | TPPR-V-1040 |
| RCM | TPPR-V-1050 |

Note: The PC configuration software has not been assessed by DEKRA Exam. If this software is used to configure the TPPR system the configuration must be verified before use, for example by confirming the printed system configuration and channel configuration reports.

Note: The power supply units have not been assessed by DEKRA Exam. Any suitable power supply may be used.

CERTIFICATION

14.3.2 Special Conditions for Use When Used for Explosion Protection

Refer to certificate **BVS16 ATEX G 002 X**.

When using 4-20 mA transmitters, pay particular attention to the following:

- - The specifications of the 4-20 mA interface
- - Behaviour with currents less than 4 mA
- - Behaviour with currents in excess of 20 mA

For each channel, the alarm with the highest significance for safety shall be configured as Latching.

Time delayed relays should not be used for safety related purposes. If their use is unavoidable, the delay time shall be set to the minimum possible for the required operation. The maximum possible rate of increase of gas concentration shall be taken into account when determining the delay time.

A latching Fault Relay shall be associated with each channel using Sensepoint ppm catalytic sensors to achieve a reliable indication in the event of the sensor being flooded with high gas concentrations. A Master fault relay may be configured where appropriate, or one or more designated relays configured in the Cause and effect matrix.

All controls, including digital inputs, inputs from webserver and inputs from Modbus shall be protected against unauthorised or inadvertent interference or operation.

When monitoring flammable gases or vapours, the following configuration limits shall be observed:

- - The parameter **Under Range Fault Limit** shall not be set below -10 %FSD.
- - The parameter **Zero Suppression Positive** shall not be set above +5 %FSD.

The parameter **Over Range Warning Latch** shall be set to latching when used with remote sensors or transmitters which may give indications within their measuring range at gas concentrations above the configured measuring range.

When monitoring oxygen, the following configuration limits shall be observed:

- The parameter **Under Range Fault Limit** or the parameter **Zero Suppression Negative** shall not be set below -2 %FSD.
- The parameter **Zero Suppression Positive** shall not be set above +2 %FSD.

14.3.3 Special Conditions for Use When Used for Measurement of Toxic Gases or Oxygen

Refer to Certificate **PFG 16 G 002 X**.

When used as EN 45544-2 apparatus, Touchpoint Pro is suitable for use with transmitters where the output at the limit value is between 4.96 mA and 12 mA.

When using 4-20 mA transmitters, pay particular attention to the following:

- The specifications of the 4-20 mA interface
- Behaviour with currents less than 4 mA
- Behaviour with currents in excess of 20 mA

For each channel, the alarm with the highest significance for safety shall be configured as Latching.

Time delayed relays should not be used for safety related purposes. If their use is unavoidable, the delay time shall be set to the minimum possible for the required operation. The maximum possible rate of increase of gas concentration shall be taken into account when determining the delay time.

All controls, including digital inputs, inputs from webserver and inputs from Modbus shall be protected against unauthorised or inadvertent interference or operation.

When monitoring oxygen, the following configuration limits shall be observed:

- The parameter **Under Range Fault Limit** or the parameter **Zero Suppression Negative** shall not be set below -2 %FSD.
- The parameter **Zero Suppression Positive** shall not be set above +2 %FSD.

When monitoring toxic gases, the following configuration limits shall be observed:

- The parameter **Under Range Fault Limit** shall not be set below -10 %FSD.
- The parameter **Zero Suppression Positive** shall not be set above the lower limit of measurement when used according to EN 45544-2.
- The parameter **Zero Suppression Positive** should not be set above +5 %FSD when used according to EN 45544-3.

CERTIFICATION

14.3.4 Configuration of Relay Outputs for safety-related switching operations

The System State relays and any other relays configured for safety purposes should be wired to a continuously monitored system for safe operation. This is to ensure that all system faults are detected promptly and appropriate action taken

Each ROM output must be configured as Normally Energized, Alarm Update Enable not selected, and Latch Function selected, as shown in the following example:

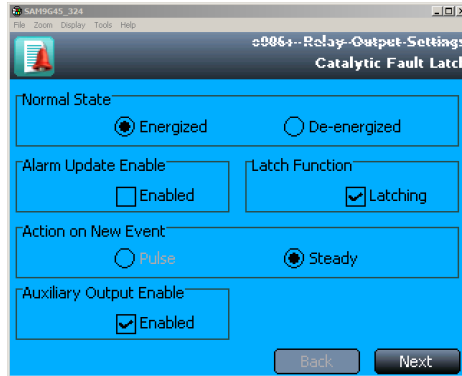

Figure 42. Fault Latch Output Configuration

14.3.5 Compliance with EN 45544-2 (Toxic Gases)

The lower limit of measurement of Touchpoint Pro is 0.08 % of the transmitter’s full scale deflection. Therefore the zero suppression positive parameter must not be set higher than 0.08 % of the transmitter’s full scale deflection to avoid suppression of valid measured values.

To maintain compliance with EN 45544 the calibration interval must not exceed 6 months.

Touchpoint Pro is suitable for use with transmitters where the output at the limit value is between 4.96mA as 12.0 mA. Please refer to EN4544-1 Annex A for further information.

14.3.6 Compliance with EN 50104 (Oxygen)

TPPR is approved for measurement of oxygen deficiency, enrichment and inertisation.

14.4 Important Notes on Certification

TPPR is a fully customizable installation, so all of the possible variations cannot be certified in one guide. Instead every system will have its personalized parameters inscribed on rating labels attached to each major component (i.e. the Controller, Remote and Battery Enclosures).

For Certification and Information purposes, a tabular overview of the individual components is given in the *TPPR Technical Handbook, Ch.21 TPPR Specifications*.

Note 1: The TPPR system contains a number of commercial-off-the-shelf (COTS) items that have been independently certified by their manufacturers whose certified parameters have been incorporated into the Specification tables.

Note 2: OEMs are responsible for ensuring that their systems are certified in accordance with these tables and any 3rd-party requirements.

Note 3: Power Supply Fluctuations shall not exceed DC 18 – 32 V SELV Supply or ±10 % of nominal.

Note 4: All equipment in this manual is rated to a maximum altitude of +2000 m (6562 ft.) AGL.

Note 5: Care must be taken that the equipment is not subjected to vibration that exceeds the levels stated in EN 60079-29-1, EN 45544 and EN 50104.



WARNING

Ambient temperature: Dependent on components fitted; check individual rating plates.

AVERTISSEMENT

Température ambiante : elle dépend des composants assemblés; vérifier individuellement les plages de température.

ORDERING

15 Ordering Information

15.1 TPPR System ID Configuration

Your TPPR has a unique System ID that incorporates a Globally Unique Identifier (GUID). A typical example might be **TPPR-HW-MF-NXHXXL-ZII8421526123**, where the first 14 characters show the system's configuration and the last 13 characters are the GUID (see box-out below).

The System ID and GUID are produced in digital, human and barcode reader formats for ease of tracking and quality control. They can be found on both the TPPR rating plate and in the UI software.

The following table shows how your TPPR System ID is constructed and this GUID can be used to provide valuable information to Technical Support if you need technical help or warranty service.

| System ID | Product Name | Unit Type | Variant* | Ventilation | Plinth | Logo | BIB | CCB-R | UI |
|--------------------|--------------|---------------------|--|-------------|-----------|---------------|------------|----------------|-------------------------|
| See Example below. | TPPR | HW = Wall Mount | S = Small M = Medium L = Large + F = Front Access R = Rear Access | X = None | X = None | X = None | X = None | X = None | L = Local (With UI) |
| | | N = Natural | | | | | | | |
| | | HF = Floor Standing | | F = Forced | P = 100mm | H = Honeywell | M = Modbus | R = Redundancy | R = Remote (Without UI) |
| Example: | TPPR- | HW- | MF- | N | X | H | X | X | L |

Table 19. TPPR Standard System ID Configuration Chart

FS = Front Access Floor Cabinet with 5 Backplanes
 RS = Rear Access Floor Cabinet with 5 Backplanes
 TS = Small Stainless Steel Wall Cabinet
 Z = Zone 2 Div. 2 Stainless Steel Wall Cabinet

S = Supplier Code i.e. Z for HA Poole UK
 II = Bill of Materials Issue Number
 PPP = Part Code i.e. 842 for a standard WM Enclosure
 YY = Year of Manufacture
 WW = Week of Manufacture
 NNN = Sequential Serial Number

ORDERING

15.2 TPRR Components Part Numbers

The following table lists some common TPRR components that are held by your local Honeywell Service Centre.

| Item | Description | Part Number |
|------|--|----------------|
| 01 | SD Card, 4 Gb, FAT32 | TPPR-V-0842 |
| 02 | Analogue Input Module 4-20 mA | TPPR-V-1000 |
| 03 | Analogue Input Module mV-Bridge | TPPR-V-1010 |
| 04 | DC-UPS 40 A Module | TPPR-V-0501 |
| 05 | Digital Input Module | TPPR-V-1030 |
| 06 | Relay Output Module | TPPR-V-1040 |
| 07 | Ring Coupling Module | TPPR-V-1050 |
| 08 | Power Supply Redundancy Module 40 A | TPPR-V-0500 |
| 09 | PSU 10 A, 240 W, 24 VDC | TPPR-V-0503 |
| 10 | PSU 20 A, 480 W, 24 VDC | TPPR-V-0504 |
| 11 | PSU 5 A, 120 W, 24 VDC | TPPR-V-0502 |
| 12 | Battery Sealed Lead-Acid 12 Ah 12 V (pair) | TPPR-V-0406 |
| 13 | Battery Sealed Lead-Acid 27 Ah 12 V (pair) | TPPR-V-0405 |
| 14 | Modbus® Interface Board | TPPR-V-2130 |
| 15 | Redundant Control Centre Board | TPPR-V-2120 |
| 16 | Battery Fuse 20 A (Cartridge) | Local Purchase |
| 17 | Backplanes Fuse 20 A (White Bladed) | Local Purchase |
| 18 | CMA, Light & Fan Fuse 5 A (Brown Bladed) | Local Purchase |
| 19 | UPS Fuse 25 A (Yellow Bladed) | Local Purchase |

Table 20. Spare Parts List

Please contact your local Honeywell Service Centre (see back page) if you want to order these parts as spares.

Some items are not listed as they are only available to Honeywell Service Centres, OEMs and Partners.

Unlisted expendable items (i.e. air filters) will be replaced as part of routine Field Service if required.



WARNING

The equipment specified in this manual is only to be installed by the Manufacturer's trained personnel, or by competent persons trained in accordance with the Manufacturer's installation instructions.

SAFE DISPOSAL

16 Disposal of Redundant / Unserviceable Parts

TPPR components must be disposed of in accordance with local and international laws. They shall not be disposed of by incineration or as domestic waste.



CAUTION – HEALTH AND ENVIRONMENTAL HAZARDS

PCB and Backplane e-waste is hazardous due to the presence of toxic substances such as Cadmium, Chromium, Lead, and Mercury, and flame retardants such as polybrominated biphenyls and diphenylethers.

Always dispose of e-waste in accordance with the WEEE Directive; do not dispose of it in domestic waste.

16.1 Restriction of Hazardous Substances (RoHS) Directive

TPPR is compliant with the requirements of the RoHS Directive.

16.2 Waste Electrical and Electronic Equipment (WEEE) Directive



This symbol indicates that the product and/or parts of the product may not be treated as household or municipal waste.

Waste electrical products (end of life) should be recovered/recycled where suitable specialist WEEE disposal facilities exist. For more information about recycling of this product, contact your local authority, your local agent or distributor, or the manufacturer whose details are on the back page.

16.3 TPPR System Construction

The TPPR system contains the following materials:

16.3.1 TPPR Safe Area Enclosures:

- Powder coated mild steel
- Zintec
- Polyamide PA 6.6 V0 (UL94)
- e-Waste (Backplane, PCB, Copper cables and terminals)

16.3.2 TPPR Battery Enclosure

The TPPR Backup Battery enclosures may contain 12 VDC Sealed Rechargeable Lead-Acid Batteries (SLAB). These batteries contain toxic and corrosive substances that may cause injury or damage if the batteries become damaged, or if they are mishandled, incinerated or disposed of incorrectly.



CAUTION – BATTERY HANDLING AND DISPOSAL

Batteries should be disposed of separately from household waste and in accordance with local laws and regulations. Unwanted batteries shall be taken to a collection point designated by local authorities.

Always dispose of batteries in accordance with the WEEE Directive; do not dispose of them in domestic waste.

16.3.3 TPPR 19 Inch Rack

- Powder coated mild steel
- Polyamide PA 6.6 V0 (UL94)
- e-Waste (Backplane, PCB, Copper cables and terminals)

16.3.4 TPPR I/O Modules

- Casing – Polyamide PA 6.6 V0 (UL94), grey
- Contents – printed circuit boards (PCB)

SAFE DISPOSAL

16.3.5 TPPR Power Supply Units

- Casing – Back case: Aluminium; Top case (with mesh): Steel with Nickel plating
- Contents – printed circuit boards (PCB)

16.3.6 TPPR Ring Coupling Module

- Casing – Polyamide PA 6.6 V0 (UL94), green
- Contents – printed circuit boards (PCB)

16.3.7 TPPR Backplanes

- Backplane Assemblies (i.e. PCB)

16.3.8 TPPR Packaging

TPPR outer packaging will be cardboard for wall-mounted units and ISPM15 certified 19 mm solid (not machined) woods for floor standing units. Facilities for recycling are widely available.

TPPR wall-mounted enclosure inner packaging is made from Stratocell® foam. The foam can be recycled and reused as Stratocell® where such recycling facilities exist.

TPPR floor standing units may be shipped on ISPM15 certified wooden pallets that may be reused, recycled or returned.

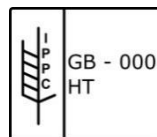

Figure 43. ISPM15 Pallet Mark Example

ILLUSTRATIONS

17 Table of Icons

| Meaning | T/screen Icon | PC Config Icon | Meaning | T/screen Icon | PC Config Icon |
|---|---|---|--|---|---|
| | | | Tool Box |  | N/A |
| About | N/A |  | Filter |  | N/A |
| About Active User | N/A |  | Firmware Update |  | N/A |
| Active Events Screen (no active events) |  | N/A | Global Settings |  | N/A |
| Active Events Screen (with active events) |  | N/A | Go to Inputs |  | N/A |
| Add User |  |  | Go to Outputs |  | N/A |
| Back |  | N/A | Help |  |  |
| CCB Configuration |  | N/A | Home |  |  |
| CCB Management |  |  | Licence Cancel | N/A |  |
| CCB Replacement |  | N/A | Licence Install | N/A |  |
| Configuration Backup |  | N/A | Licence Manage | N/A |  |
| Configuration Restore |  | N/A | Menu (T/s: select options in Input channel detail screen) (PC: configure options in System Settings) |  |  |
| Delete Configuration |  | N/A | Modbus Settings |  | N/A |
| Diagnostics |  |  | Panel Configuration |  | N/A |
| Event History |  | N/A | | | |

ILLUSTRATIONS

| Meaning | T/screen Icon | PC Config Icon | Meaning | T/screen Icon | PC Config Icon |
|-------------------------------|---|---|-------------------|---|---|
| Password Change | N/A |  | User Management |  |  |
| Regional settings |  | N/A | Zoom in (X axis) |  | N/A |
| Remove User | N/A |  | Zoom in (Y axis) |  | N/A |
| Reports |  | N/A | Zoom out (X axis) |  | N/A |
| Ring Network |  |  | Zoom out (Y axis) |  | N/A |
| Screen Locked (User Login) |  |  | | | |
| Screen Unlocked (User Logout) |  |  | | | |
| SD Card |  | N/A | | | |
| Select Language | N/A |  | | | |
| Sensor Catalogue Update |  | N/A | | | |
| Service Contact Settings |  | N/A | | | |
| System Configuration |  |  | | | |
| System Setup |  |  | | | |
| TCP/IP Settings |  | N/A | | | |
| Trend Graph Settings |  | N/A | | | |

Figure 44. Icon Table

ILLUSTRATIONS

18 List of Illustrations

| | | |
|------------|--|----|
| Figure 1. | Electrical Warning Label 1 | 8 |
| Figure 2. | Electrical Warning Label 2 | 8 |
| Figure 3. | Protective Earth (Ground) Point | 8 |
| Figure 4. | Equipment Earth (Ground) Point | 8 |
| Figure 5. | Controller Rear Cover with Example Labels | 8 |
| Figure 6. | Example of a Typical System Rating Label | 9 |
| Figure 7. | Typical TPPR Product Label | 9 |
| Figure 8. | Keep Children Away | 10 |
| Figure 9. | No Naked Flames | 10 |
| Figure 10. | Use Caution | 10 |
| Figure 11. | Electrical Hazard | 10 |
| Figure 12. | Read The Instruction Manual | 10 |
| Figure 13. | Wear Eye Protection | 10 |
| Figure 14. | Hazardous Waste (Pb = Lead) | 10 |
| Figure 15. | Recycle Only | 10 |
| Figure 16. | TPPR Building Blocks | 12 |
| Figure 17. | TPPR Controller with Remote Units and Field Devices | 13 |
| Figure 18. | TPPR Enclosures | 14 |
| Figure 19. | TPPR Controller Cover with Connection Map | 14 |
| Figure 20. | TPPR Controller | 16 |
| Figure 21. | TPPR Backplane | 17 |
| Figure 22. | TPPR Controller Typical Schematic | 17 |
| Figure 23. | Example Ring Circuit | 18 |
| Figure 24. | TPPR Module Types | 19 |
| Figure 25. | Typical Power Supply Setup | 20 |
| Figure 26. | Choice of PSU Size (120 W / 240 W / 480 W) | 20 |
| Figure 27. | Power Redundancy Module Operation | 21 |
| Figure 28. | DC-UPS and Battery Configuration | 22 |
| Figure 29. | Battery Circuit | 24 |
| Figure 30. | System Status Normal | 29 |
| Figure 31. | System Status with Example Active Events | 29 |
| Figure 32. | Touchscreen Navigation – Input and Output | 30 |
| Figure 33. | Touchscreen Navigation – Active Events | 31 |
| Figure 34. | Input Details Screen | 33 |
| Figure 35. | Outputs Screen | 33 |
| Figure 36. | Outputs Screen with filter options | 33 |
| Figure 37. | Trend Graph Screen | 34 |
| Figure 38. | Fault Latch Output Configuration | 43 |
| Figure 39. | Active Events Screen with Filter Options | 45 |
| Figure 40. | Active Events Screen Showing the Filter Option Buttons | 46 |

ILLUSTRATIONS

| | | |
|------------|----------------------------------|----|
| Figure 41. | Inputs Screen with menu options | 48 |
| Figure 42. | Fault Latch Output Configuration | 81 |
| Figure 43. | ISPM15 Pallet Mark Example | 85 |
| Figure 44. | Icon Table | 87 |

ILLUSTRATIONS

19 List of Tables

| | | |
|-----------|---|----|
| Table 1. | TPPR Access Levels | 11 |
| Table 2. | TPPR Module Types | 19 |
| Table 3. | PSU Terminal Allocation | 21 |
| Table 4. | DC-UPS Primary Terminal Allocation | 22 |
| Table 5. | DC-UPS Secondary Terminal Allocation | 22 |
| Table 6. | DC-UPS LED Meanings | 23 |
| Table 7. | Backup Battery Details | 23 |
| Table 8. | System Alert Icons | 28 |
| Table 9. | Input Channel Menu Options | 32 |
| Table 10. | Inhibit / Force Options | 34 |
| Table 11. | System State Relay Operation | 38 |
| Table 12. | Rising Gas Reading | 42 |
| Table 13. | Falling Gas Reading | 42 |
| Table 14. | Potential Issues | 62 |
| Table 15. | Error Codes and Remedies | 73 |
| Table 16. | Example of a Ring Fault Event Log | 74 |
| Table 17. | Applicable National and International Standards | 77 |
| Table 18. | National and International Certificates | 78 |
| Table 19. | TPPR Standard System ID Configuration Chart | 82 |
| Table 20. | Spare Parts List | 83 |

Find out more

www.honeywellanalytics.com

Contact Honeywell Analytics:**Europe, Middle East, Africa**

Life Safety Distribution GmbH

Javastrasse 2

8604 Hegnau

Switzerland

Tel: +41 (0)44 943 4300

Fax: +41 (0)44 943 4398

gasdetection@honeywell.com

Customer Service

Tel: 00800 333 222 44 (Freephone number)

Tel: +41 44 943 4380 (Alternative number)

Fax: 00800 333 222 55

Middle East Tel: +971 4 450 5800 (Fixed Gas Detection)

Middle East Tel: +971 4 450 5852 (Portable Gas Detection)

Americas

Honeywell Analytics Inc.

405 Barclay Blvd.

Lincolnshire, IL 60069

USA

Tel: +1 847 955 8200

Toll free: +1 800 538 0363

Fax: +1 847 955 8210

detectgas@honeywell.com

Asia Pacific

Honeywell Analytics Asia Pacific

7F SangAm IT Tower,

434 Worldcup Buk-ro, Mapo-gu,

Seoul 03922, Korea

Tel: +82 (0)2 6909 0300

Fax: +82 (0)2 2025 0328

India Tel: +91 124 4752700

analytics.ap@honeywell.com

Technical Services

EMEA: HAexpert@honeywell.com

US: ha.us.service@honeywell.com

AP: ha.ap.service@honeywell.com

www.honeywell.com

Please Note:

While every effort has been made to ensure accuracy in this publication, no responsibility can be accepted for errors or omissions. Data and legislation may change and you are strongly advised to obtain copies of the most recently issued regulations, standards and guidelines.

This publication is not intended to form the basis of a contract.

Part Number 2400M2566

Issue 4

© 2018 Honeywell Analytics

Honeywell